

STYKLISTE N.R. 62254.	STYKLISTE	STYK	STYKLISTE
4 Fjeder af 7 Blade	1		
4 Fjederbund	2		
8 Tap 5/8" x 46	3		
4 Sikring	4		
4 Mellemlæg	5		
4 Kile	6		
4 Underlag	7		
8 Møtrik 5/8"	8		
8 Split 4φ x 30	9		

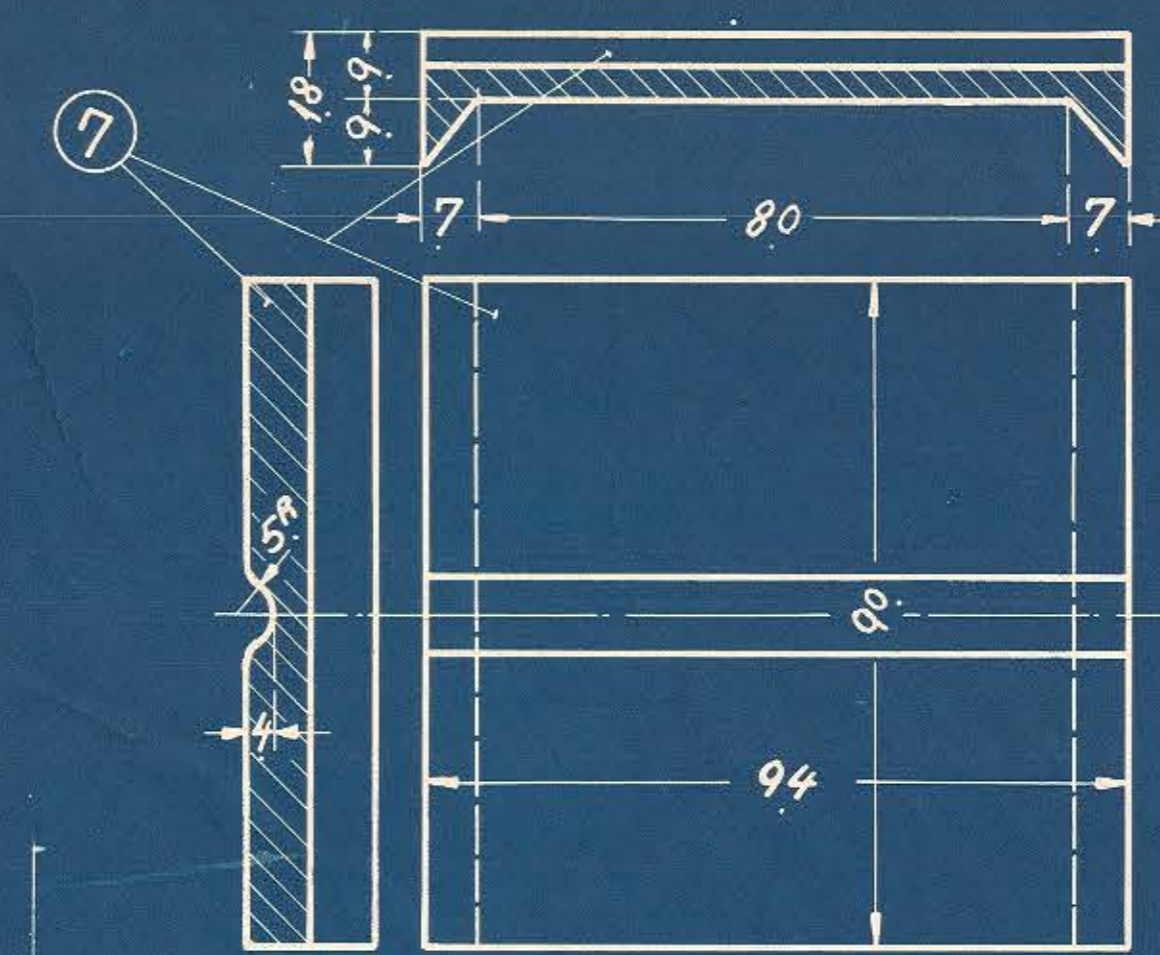

425 mm ved 3375 kg Belastning

Fjederen er tegnet ubelastet

Tegn 144L-11.10

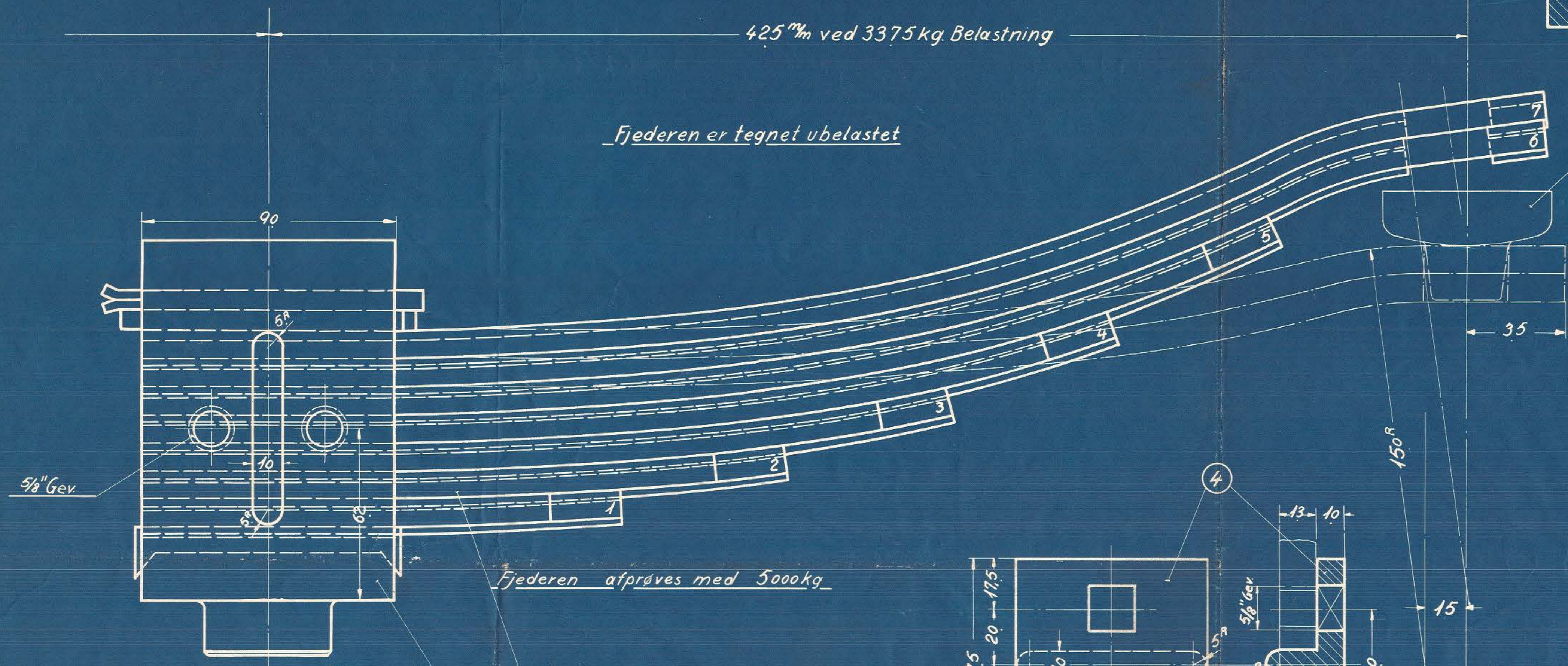

Fjederen afprøves med 5000 kg

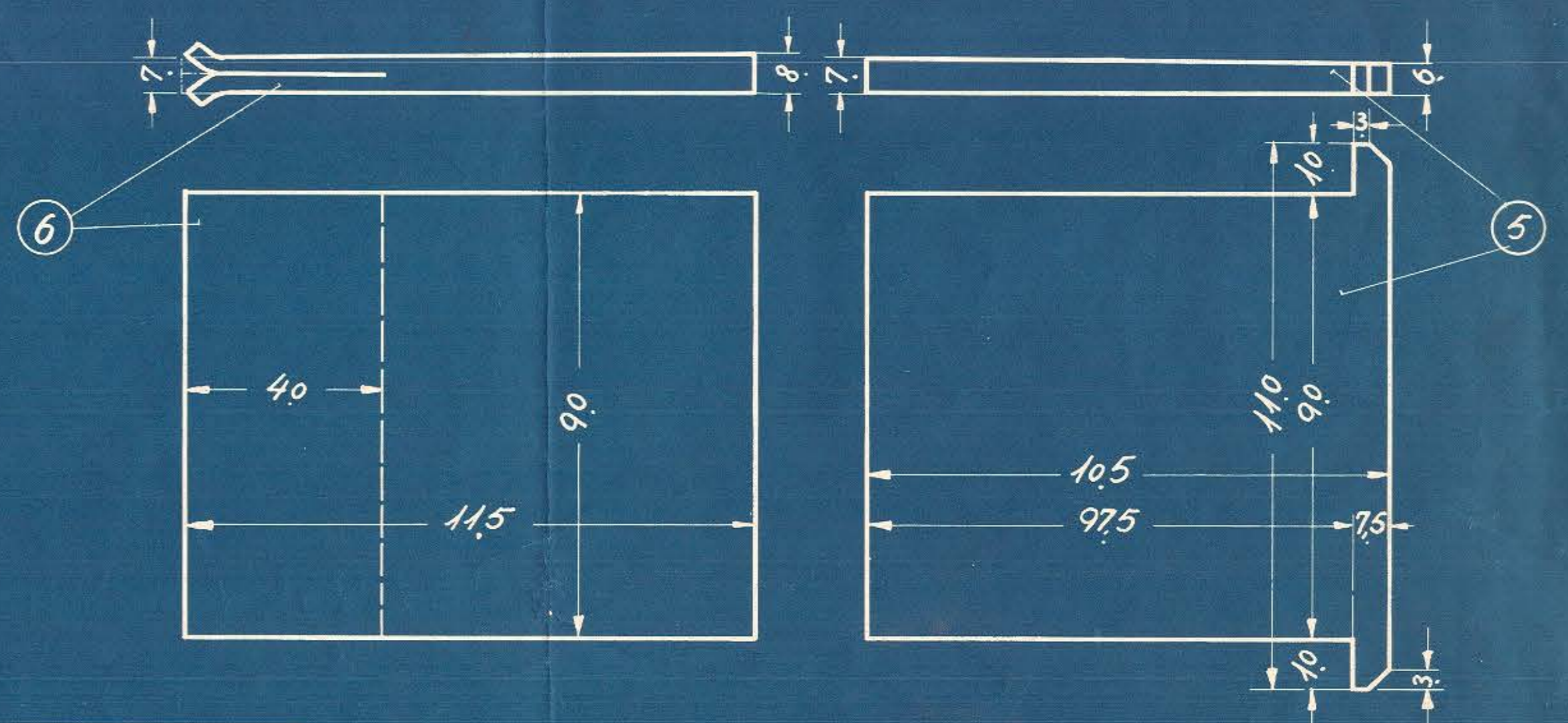
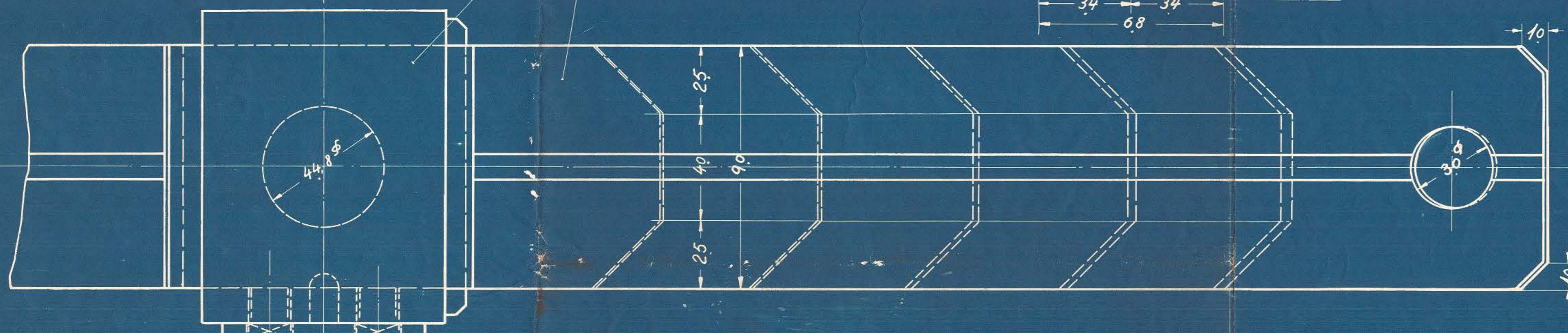
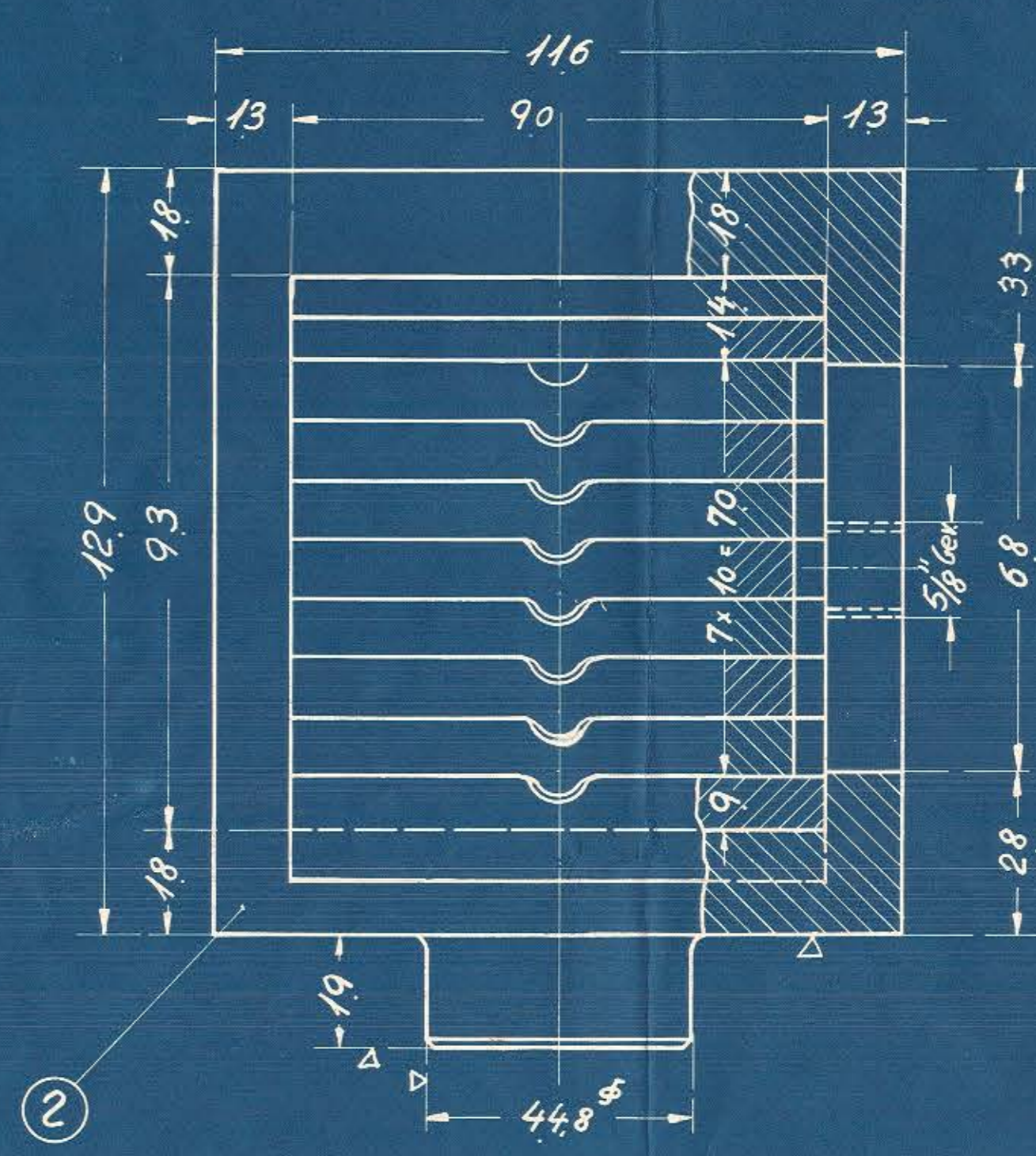

Pilhøjde ubelastet 0 kg = 80 mm
 belastet 3375 " = 30 "

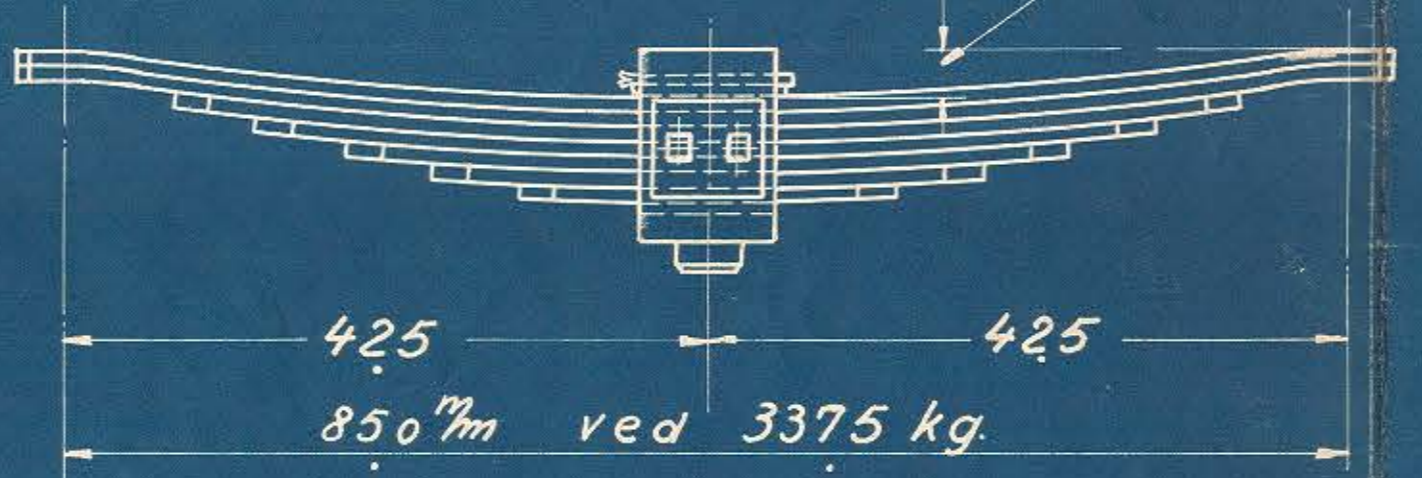

Fjederbladernes udstr. Lg.	
1	250 mm
2	370 "
3	485 "
4	606 "
5	730 "
6	930 "
7	930 "
Ialt 4300 m/m.	

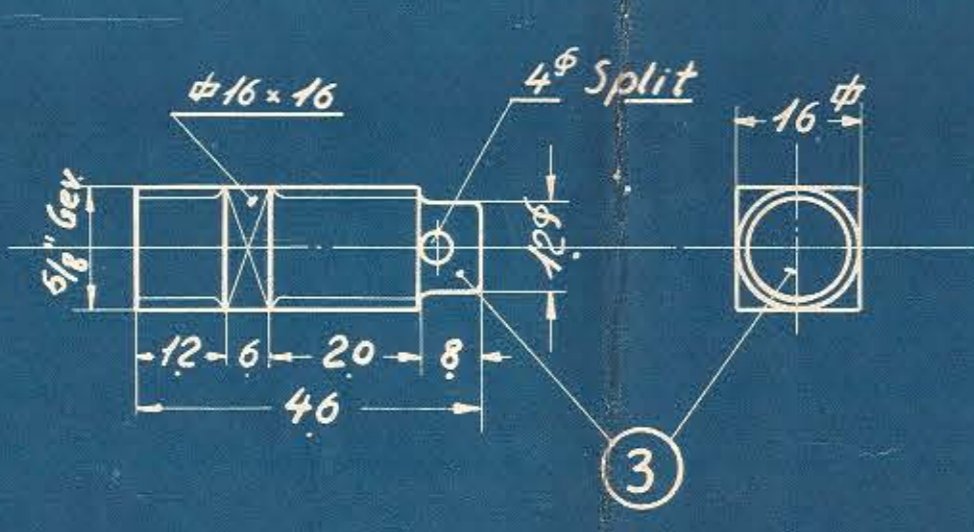

FORANDRINGER				
A/S FRICHS AARHUS		1:1	TEGNER	C.H.K.
Bærefjeder.			REVISOR	P.H.
Diesel-mek. 115/125 HK Rangert.			DATE	9-3-37
			TEGNING NR.	144L-11.04