

Uyarsat istanbul 6. Juni 1917.

Alle Bolzen, Büchsen und Angen hart!

Schmiergefäßdeckel nach Zeichen No 190.

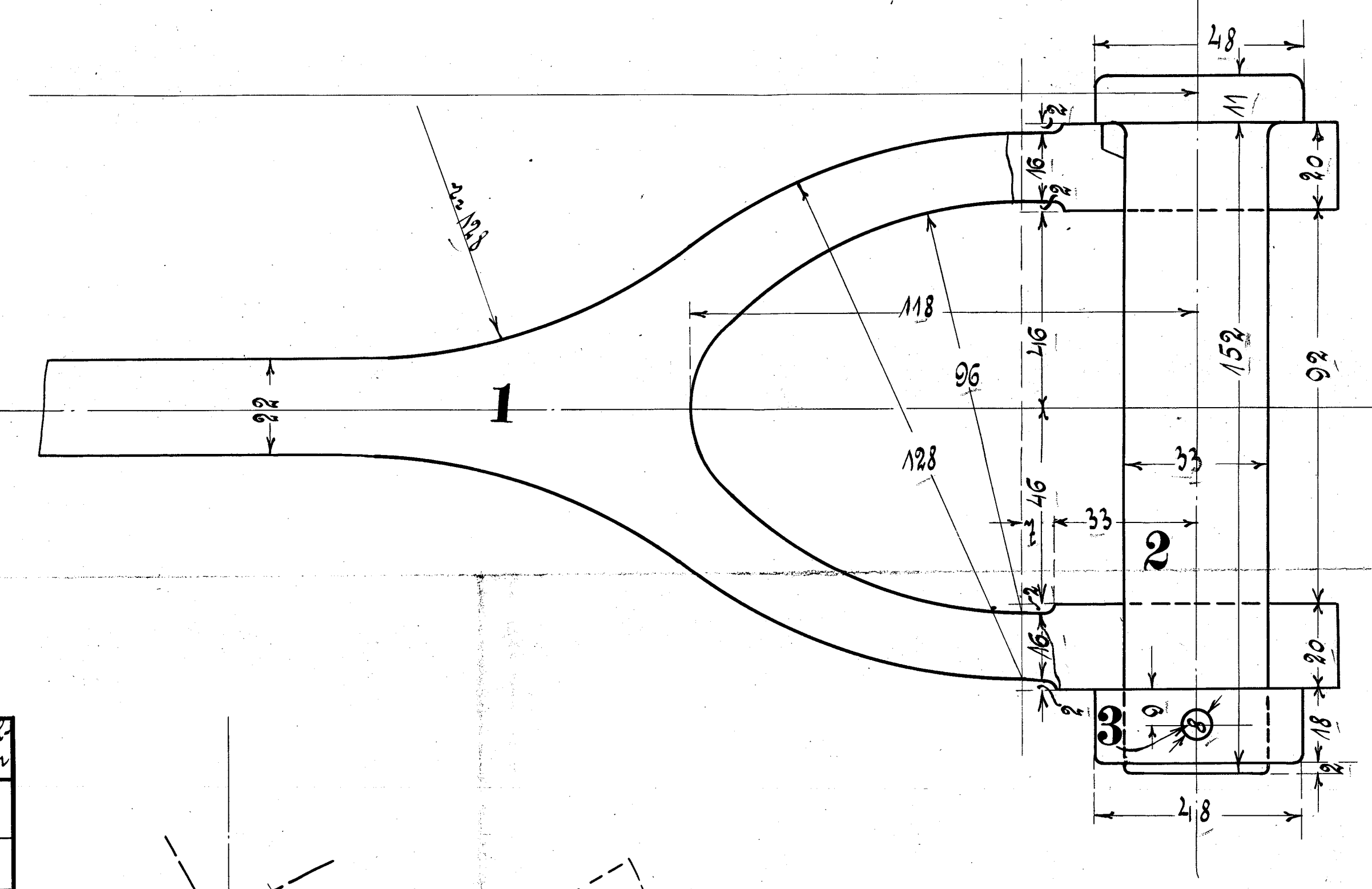
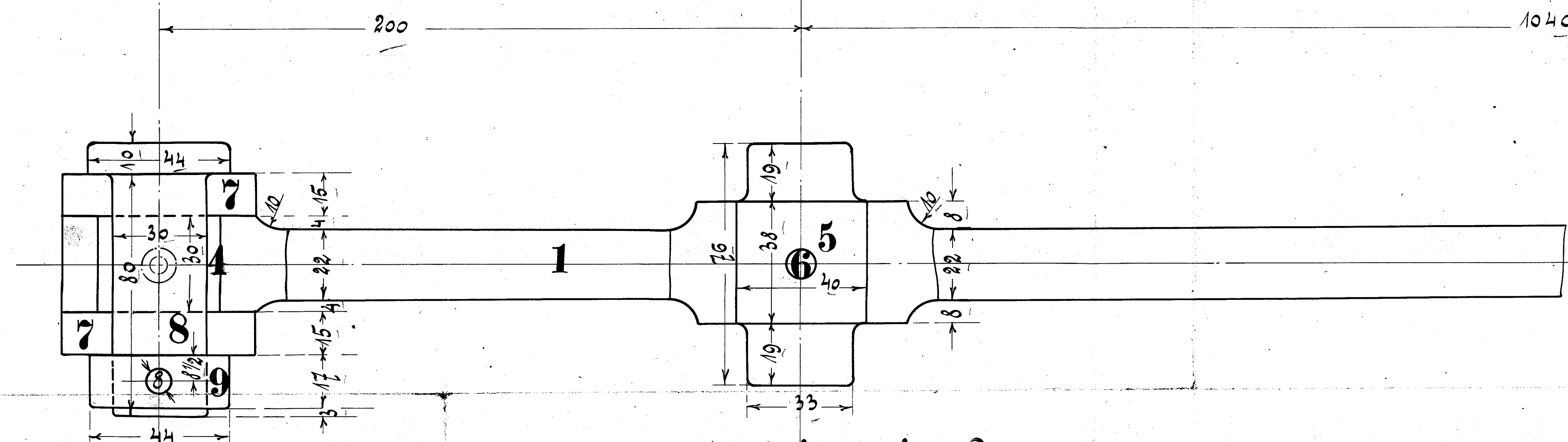
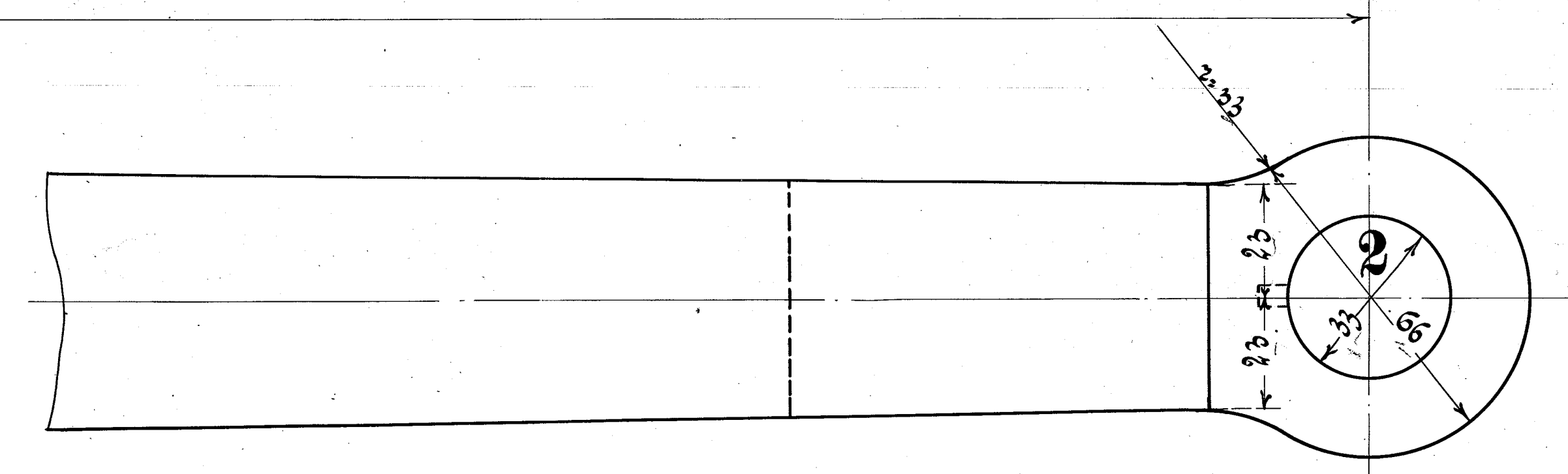
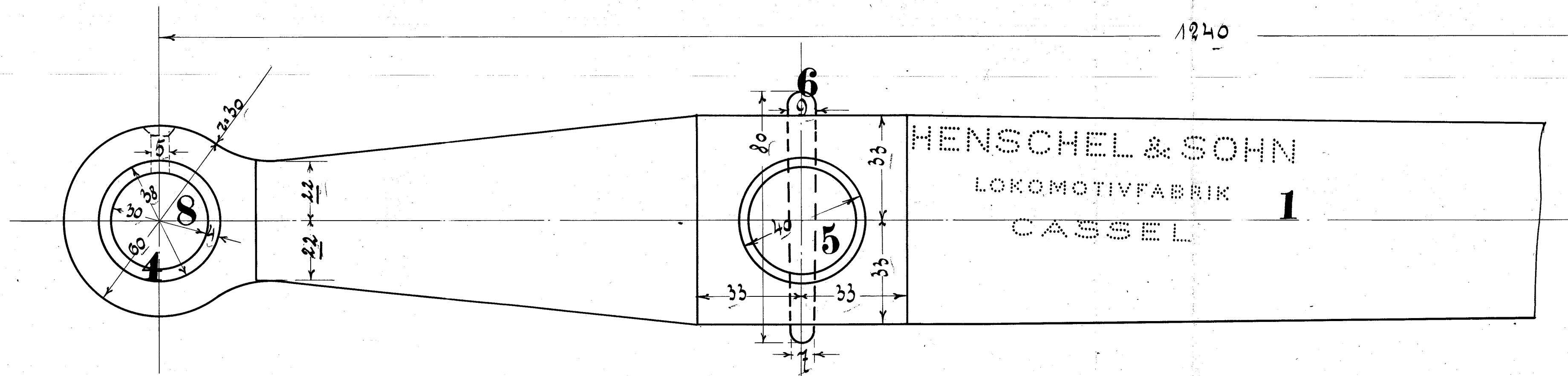
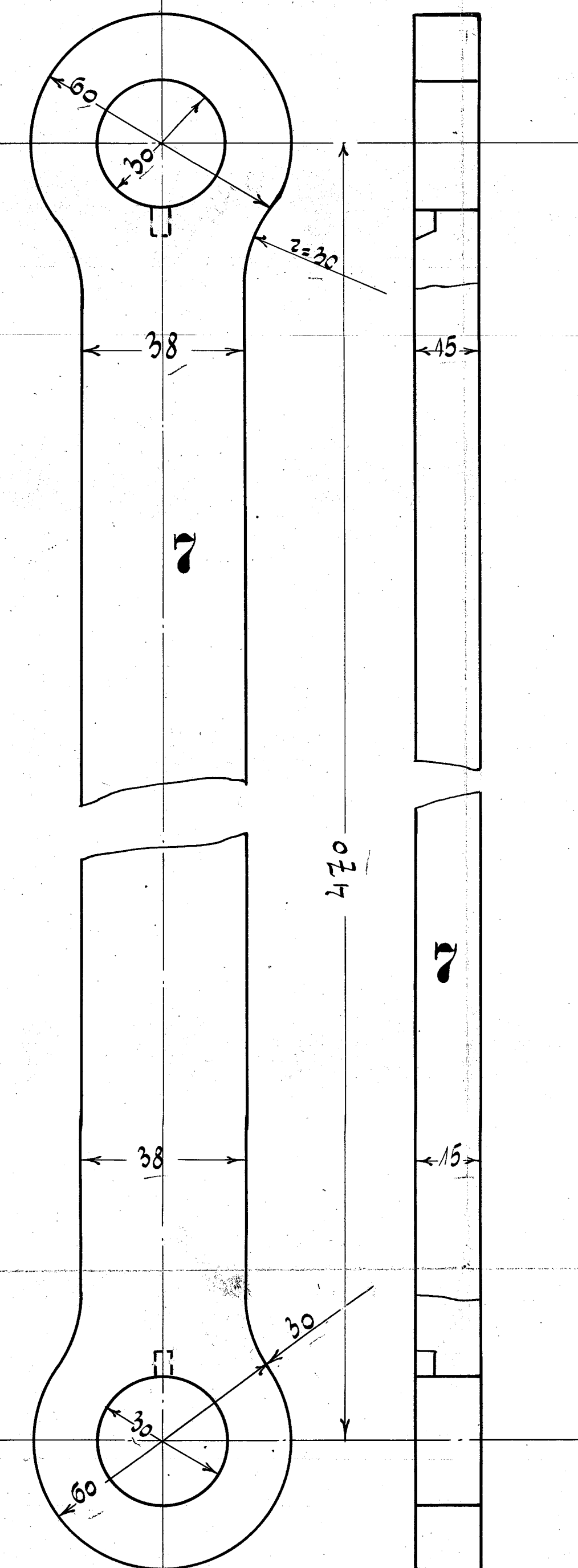

Ausführung für Lokomotive.

Stückzahl	Benennung	No	Material	Bemerkung	Bestell-Modell-merkzeichen	Stückzahl	Benennung	No	Material	Bemerkung	Bestell-Modell-merkzeichen
2	Schieberschubstangen 1 1/2	1	St. E.			4	Bolzen	8	St. E.		
2	Bolzen	2	Sto.			4	Splintringe mit Splinten	9	Sto.		
2	Splintringe mit Splinten	3	Sto.			2	Excenterstangen 1 1/2	10	Sto.		
2	Büchsen	4	Stahl			2	Büchsen	11	R. E.		
2	Bolzen	5	St. E.			2	Schrauben No 2	12	St. E.		
2	Stifte	6	Sto.			2	Muttern dazu	13	Sto.		
4	Hängereisen	7	Sto.			2	Büchsen	14	Stahl		

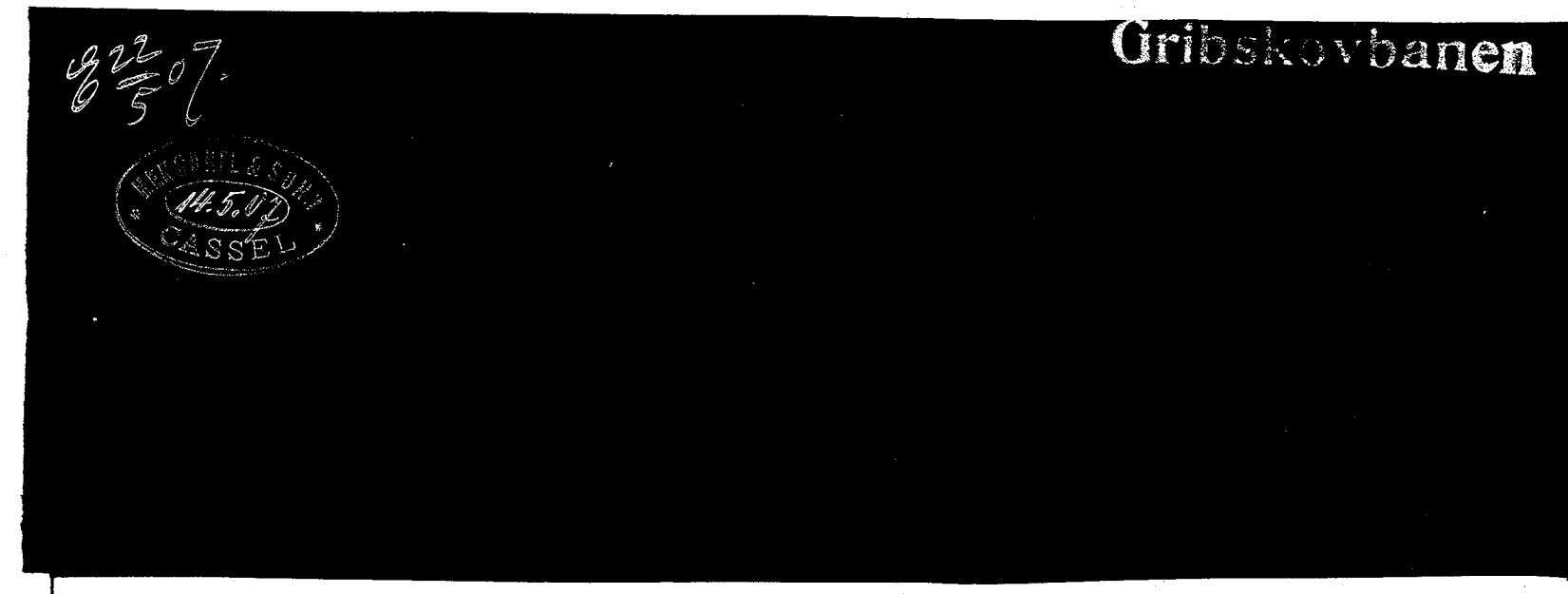
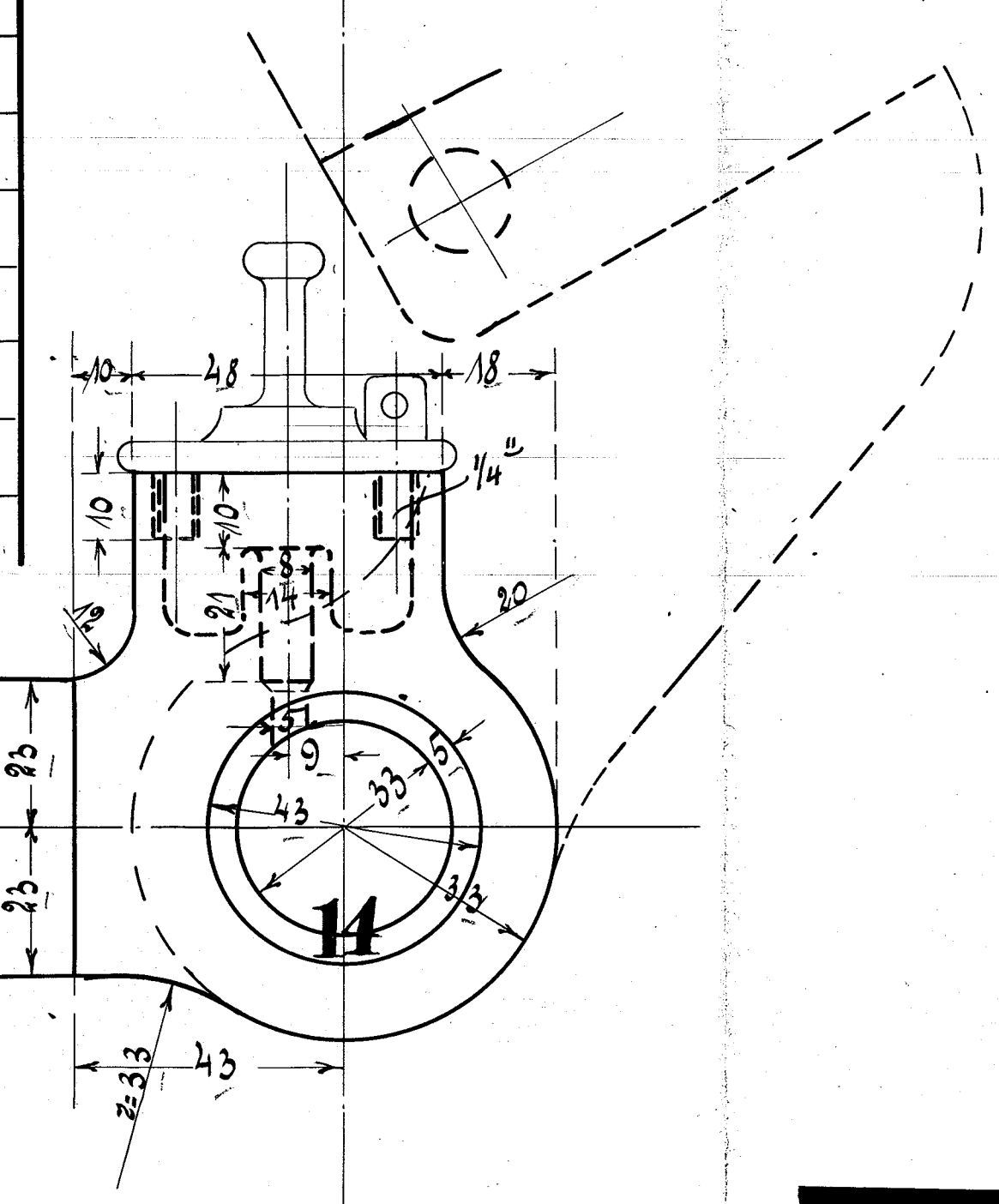
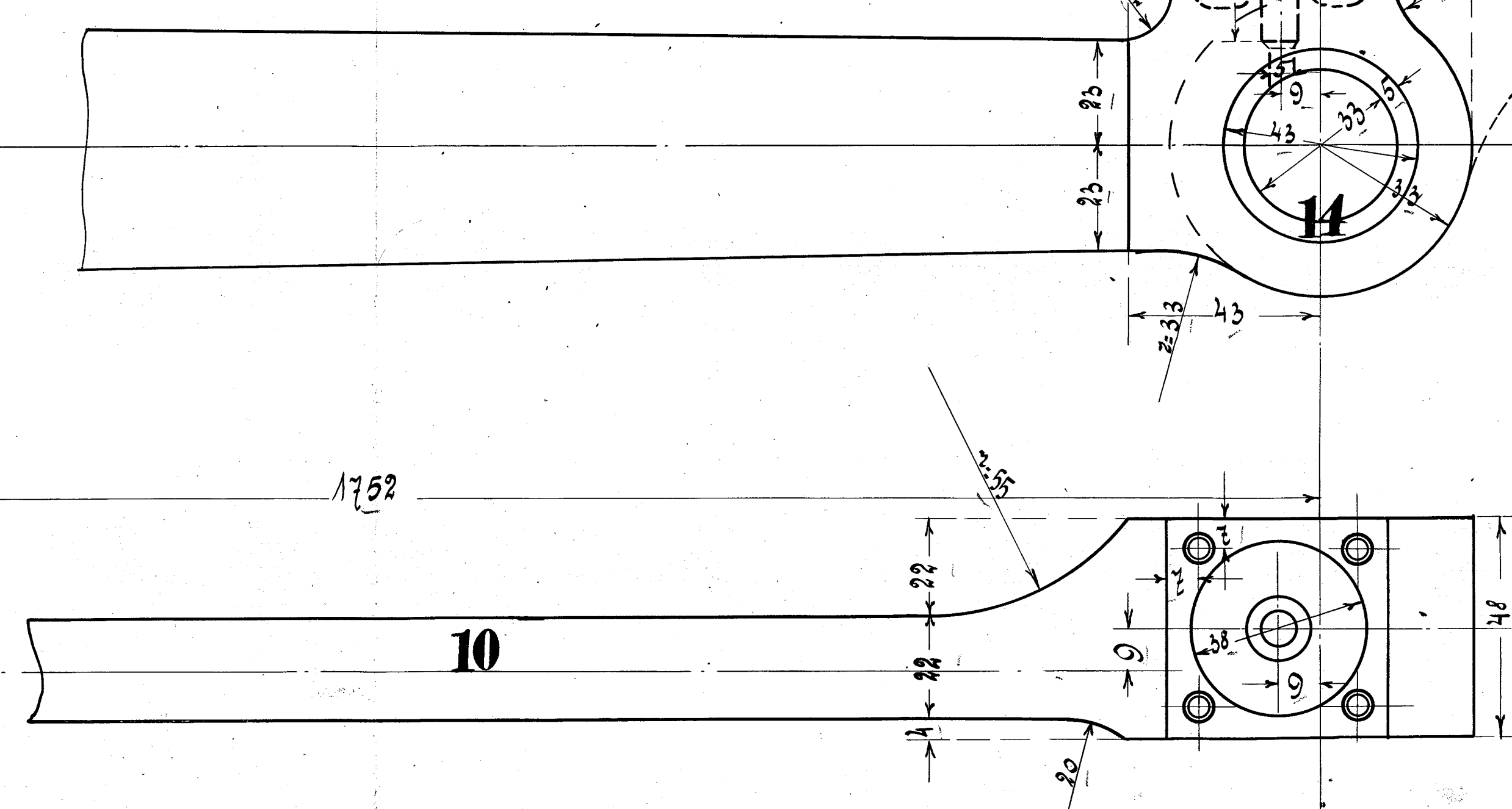
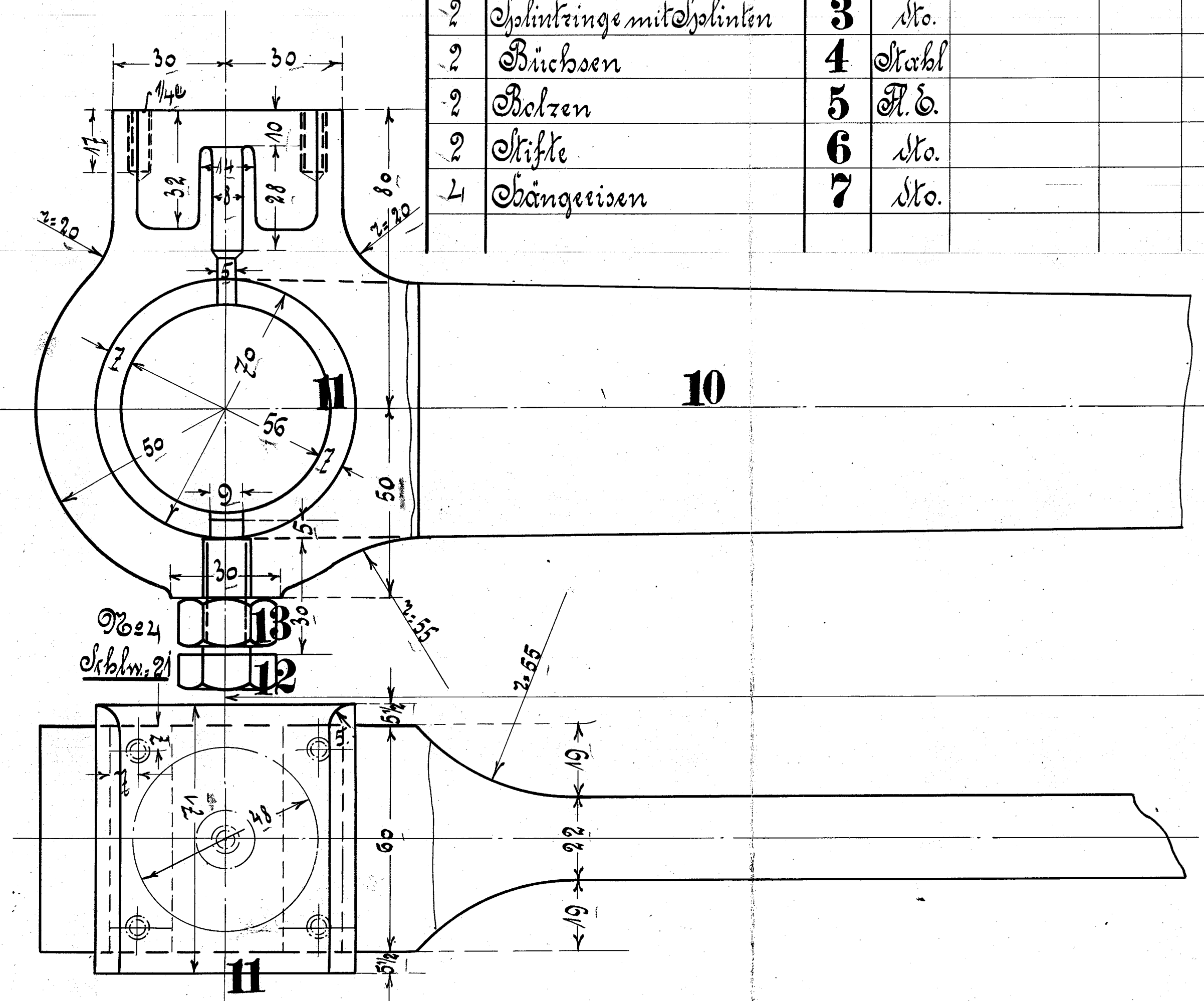

Schieberschubstangehängereisen & Excenterstange.

Zeichnung No 205.