

Privatbanegaarden i Aalborg.

Lokomotivemise med Funktionærbygning
Retiradebygning og Udvendig Bygræv med Askkasse.

For-Facade.

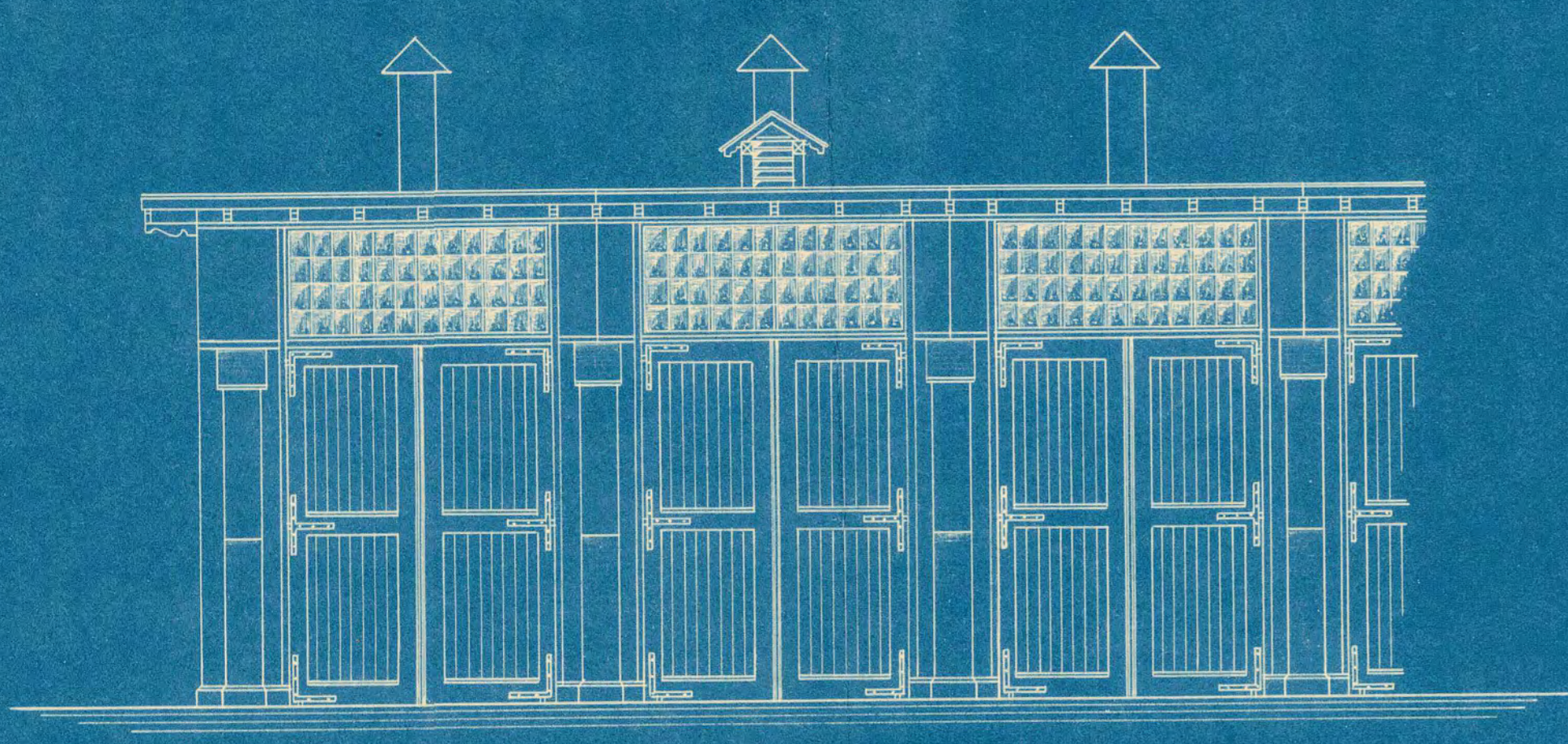

Bag-Facade.

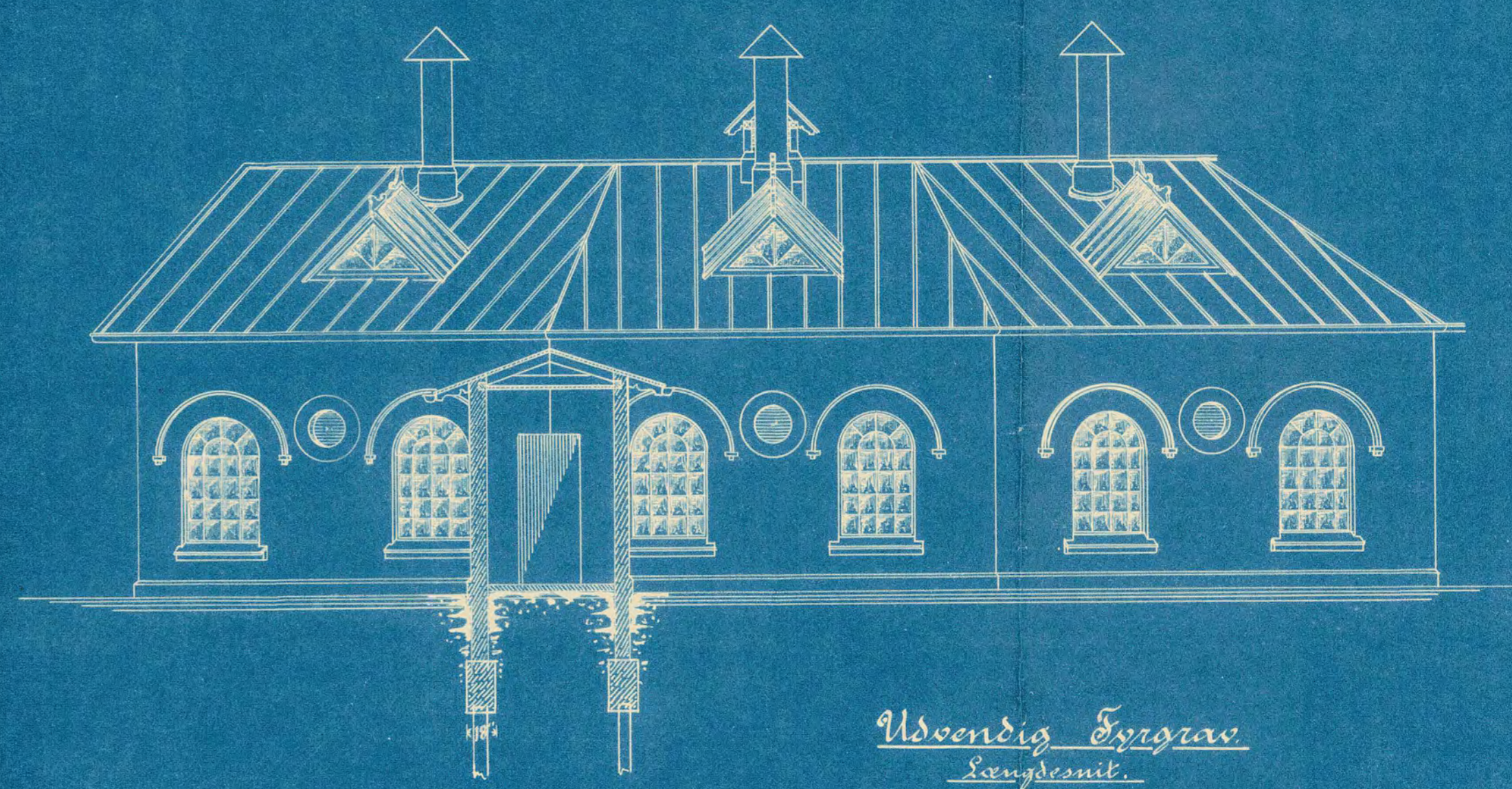

Snit a-b med Garthfacade af Funktionærbygning.

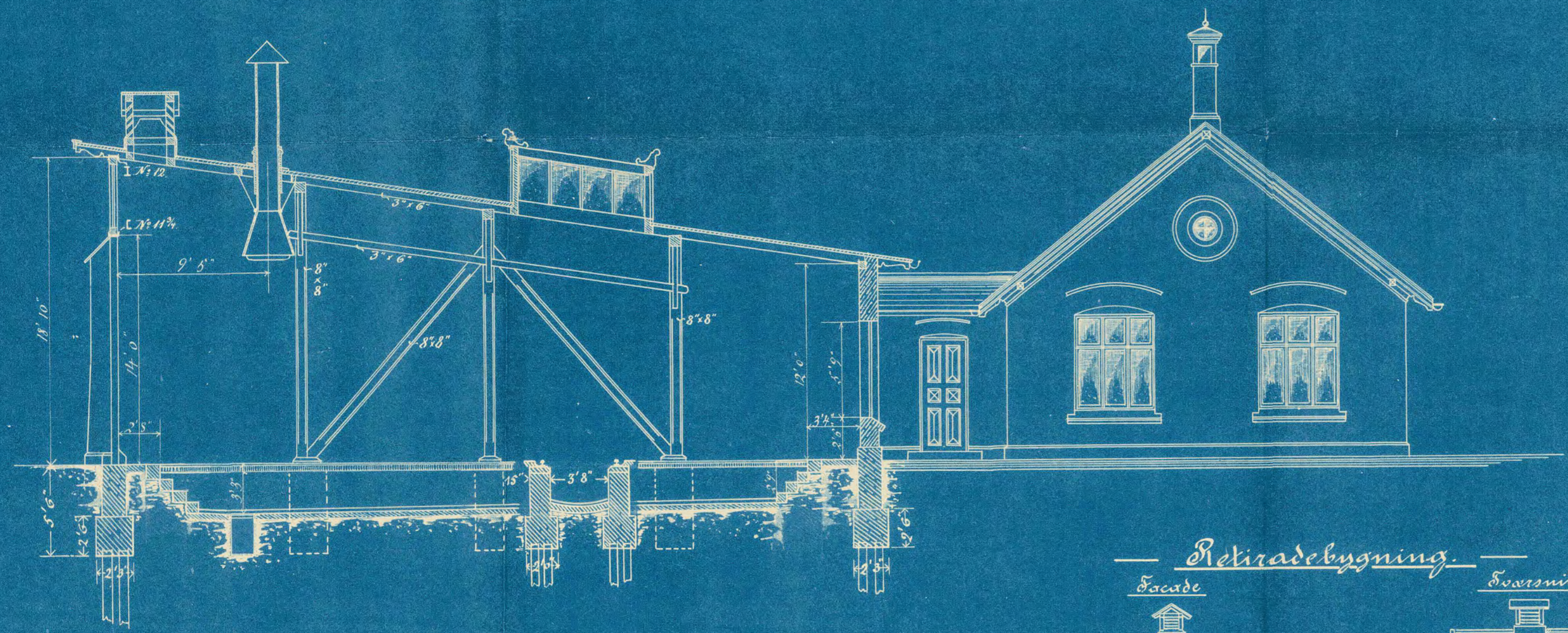

Udvendig Bygræv
Længdesnit.

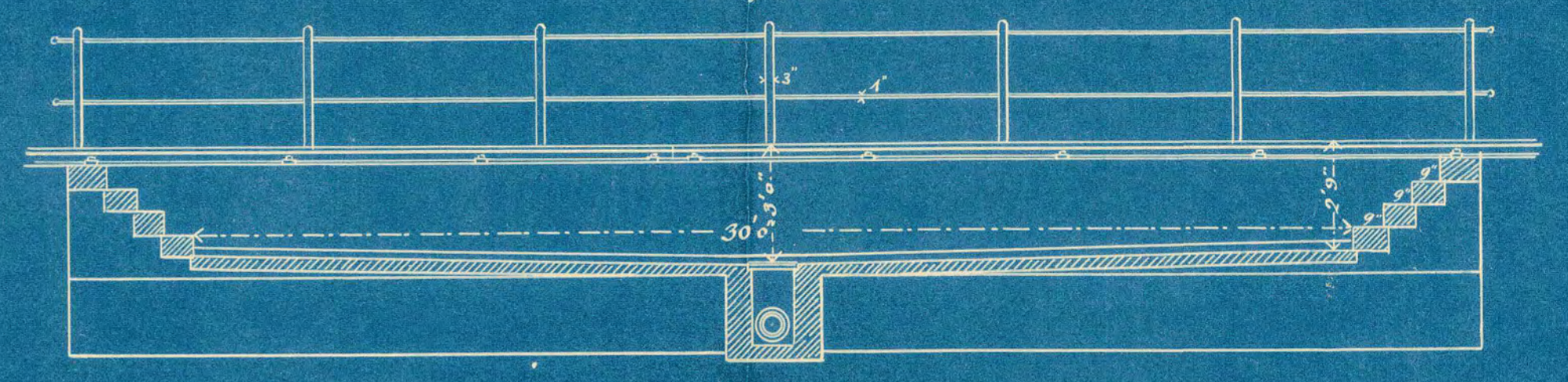

Grundplan.

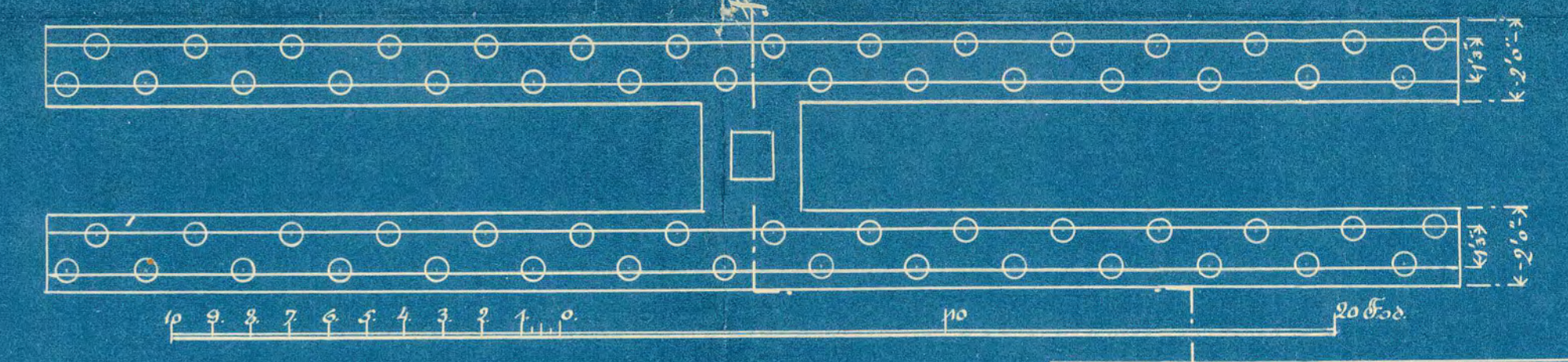

Snit c-f.

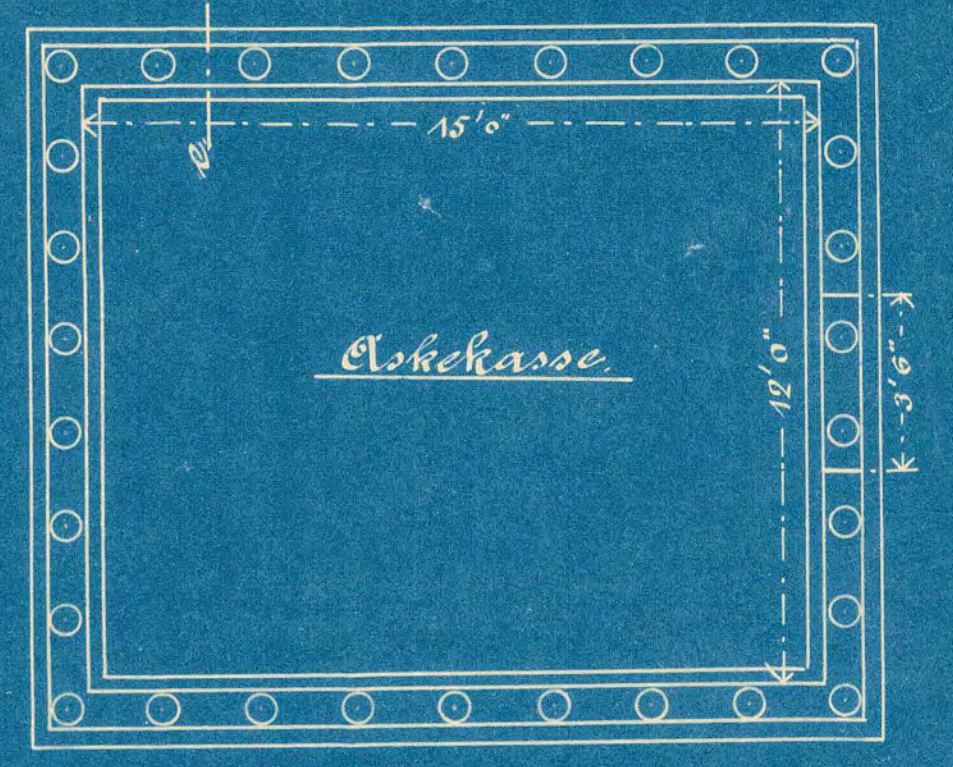
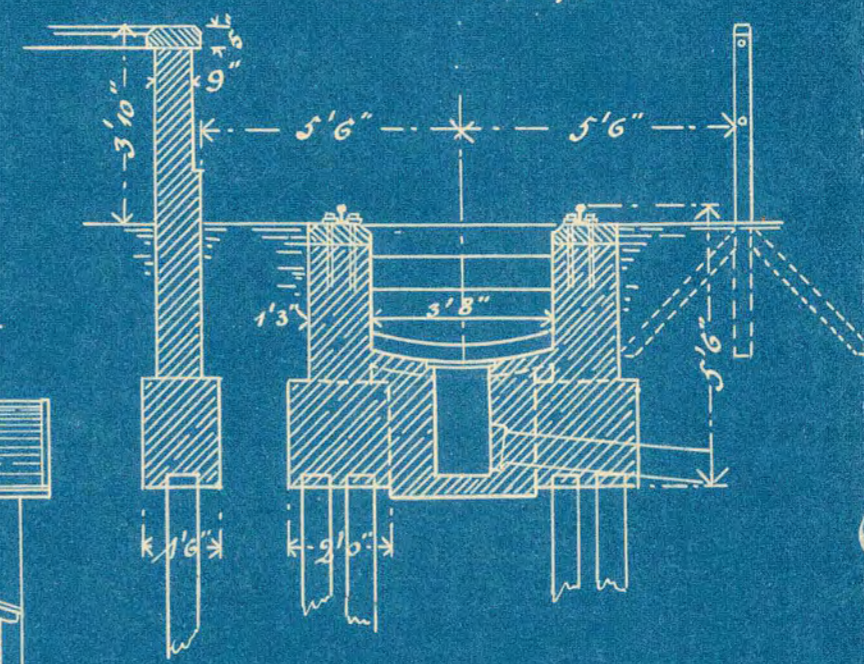

Retiradebygning.
Facade



Svarsnit

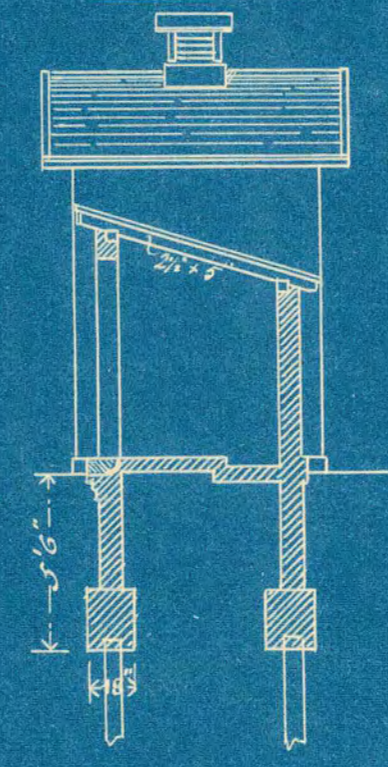

Snit e-d.

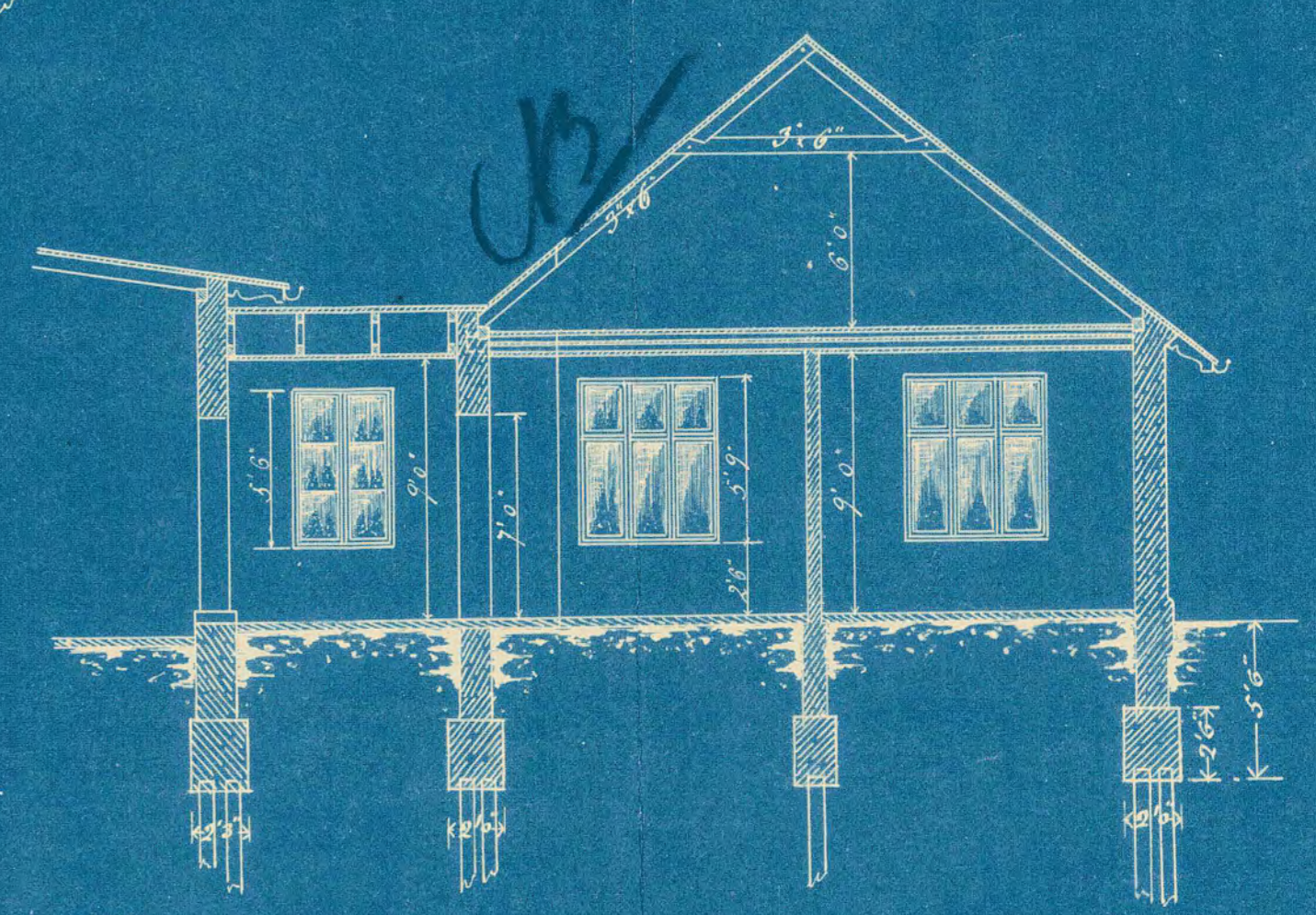

Garthfacade.

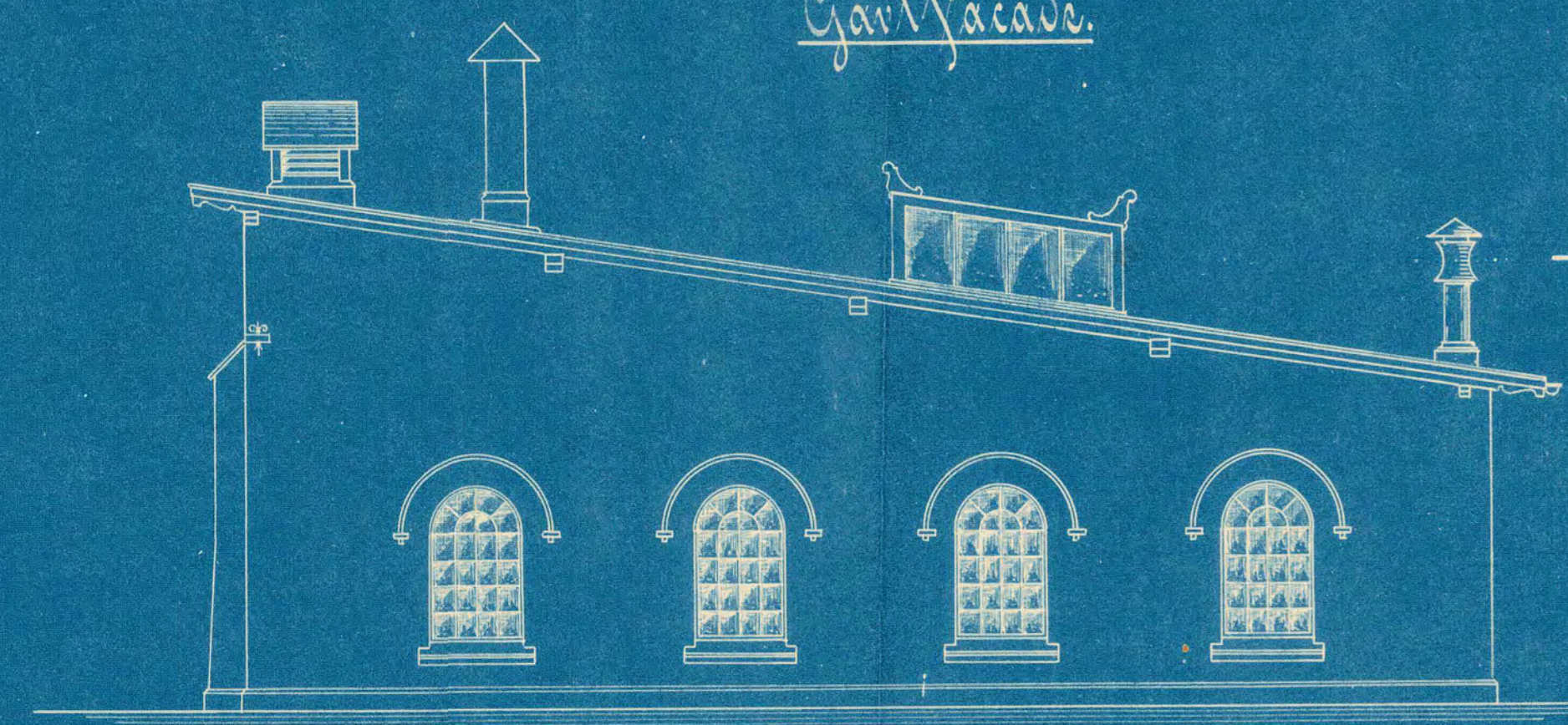

Grundplan

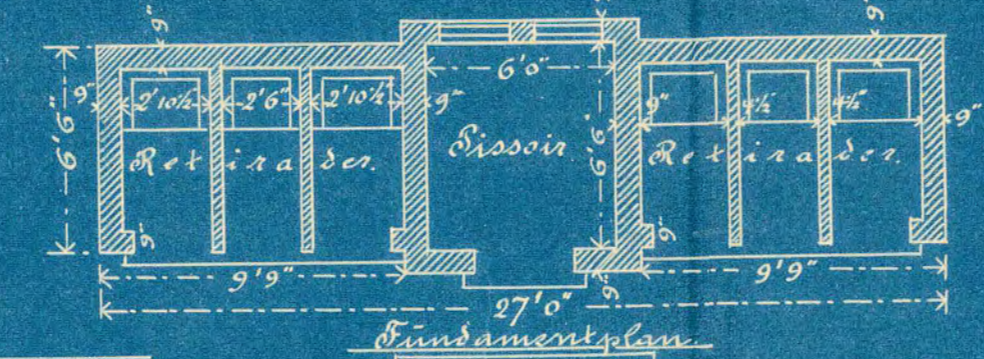

Fundamentplan

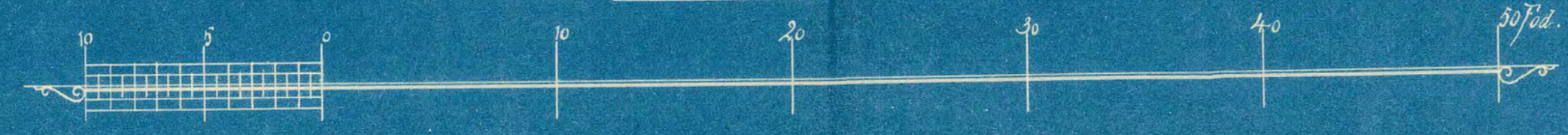
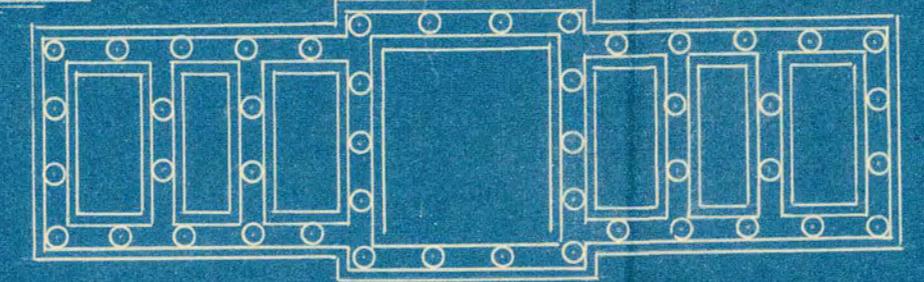

H. Schou
Arkitekt

Privatbanegaarden i Aalborg.

Lokomotivemise med Funktionærbygning
 Retiradebygning og Uvendig Begrav med Askekasse.

Før-Facade.

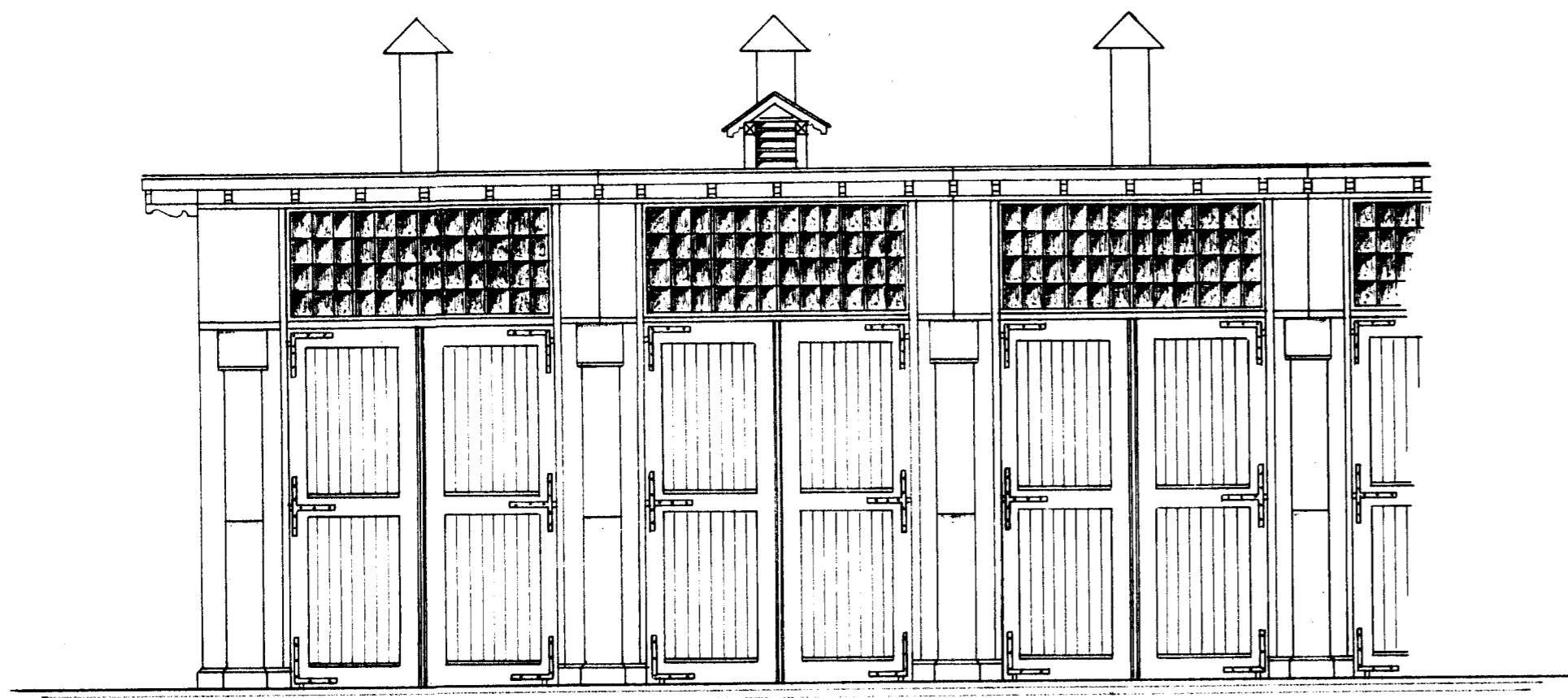

Dag-Facade.

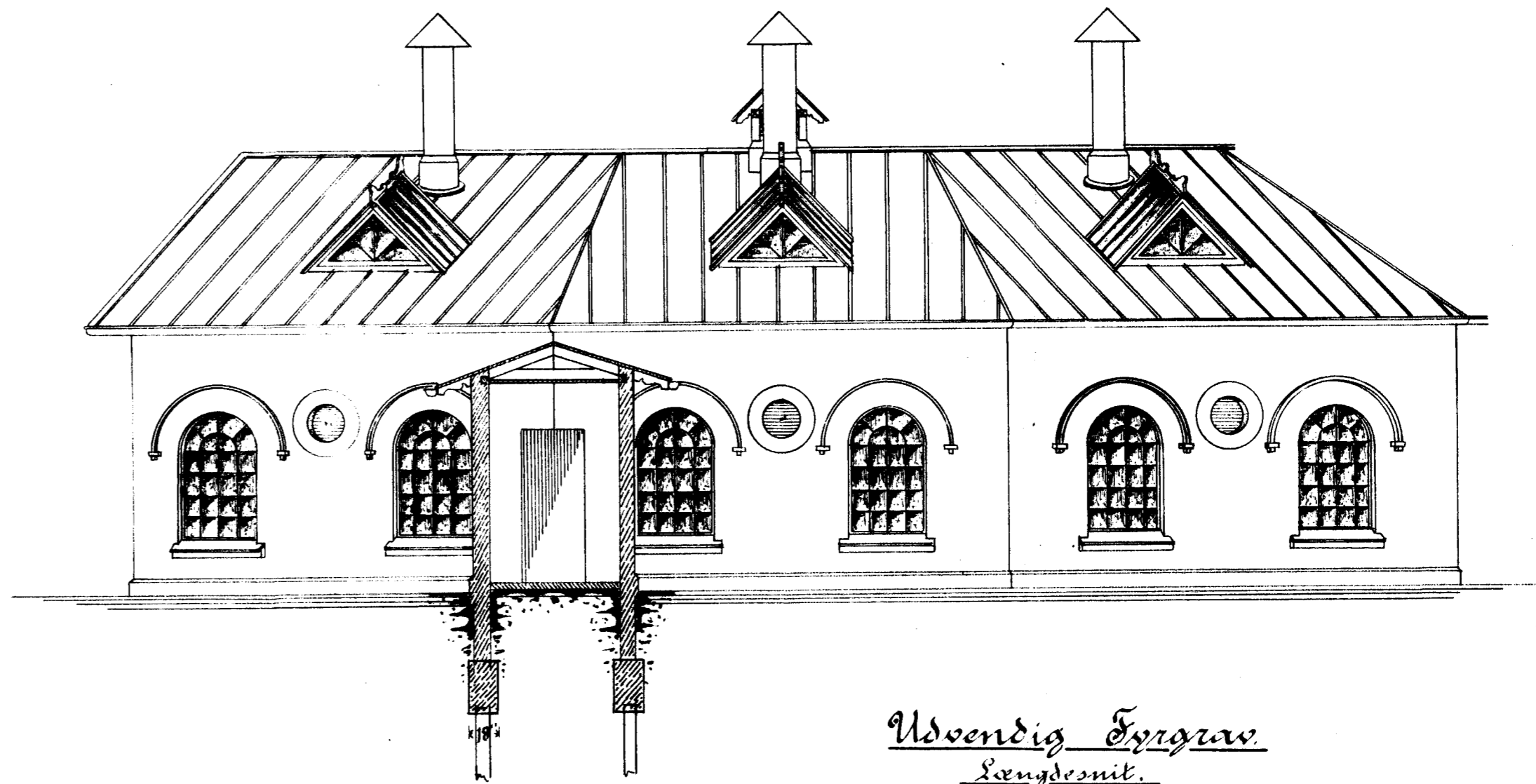

Uvendig Begrav
 Længdesnit.

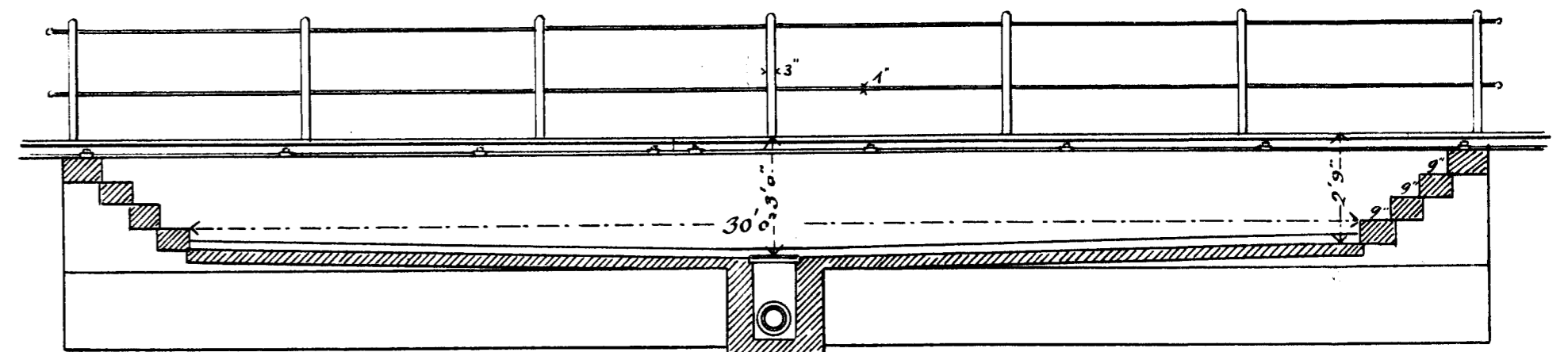

Snit a-b med Gærfacade af Funktionærbygning.

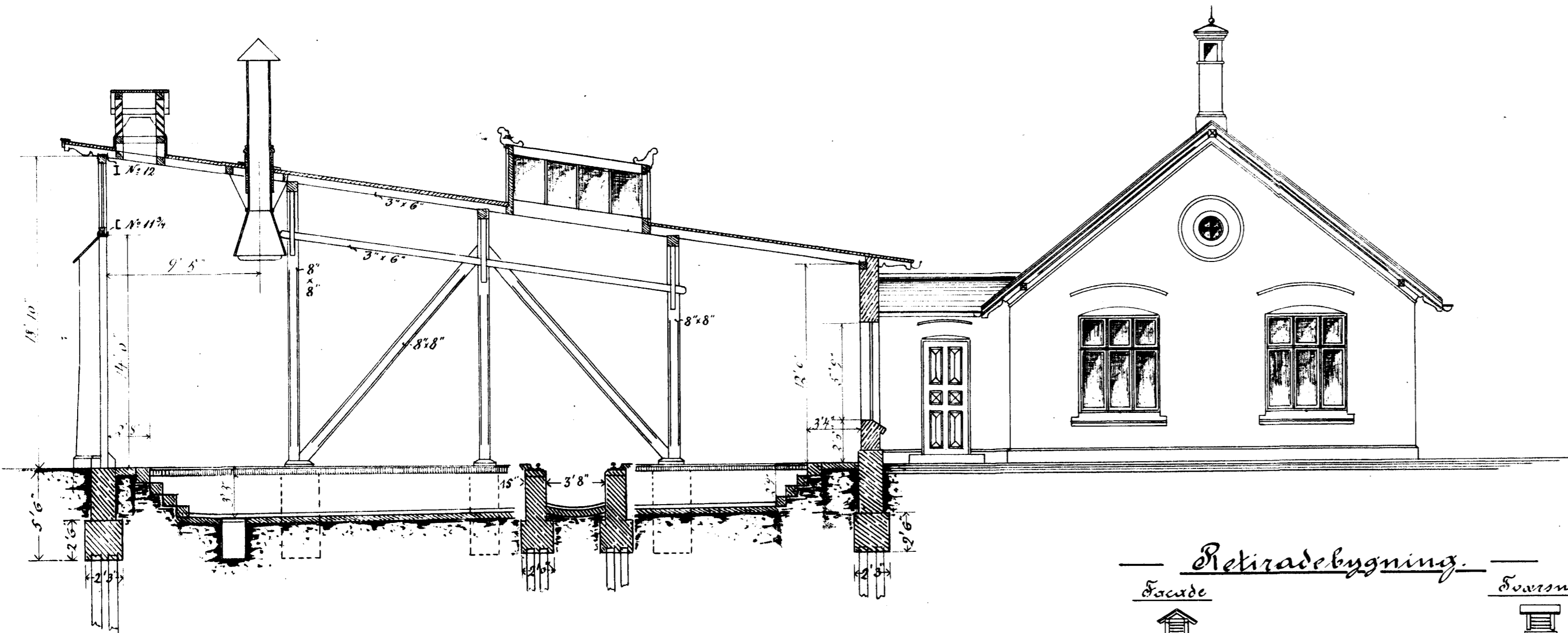

Grundplan.

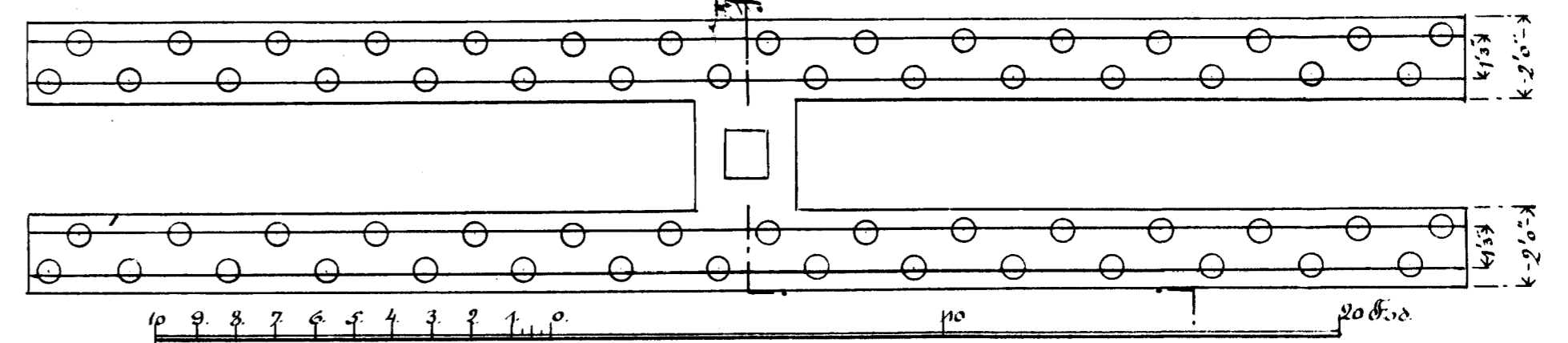

Snit e-f.

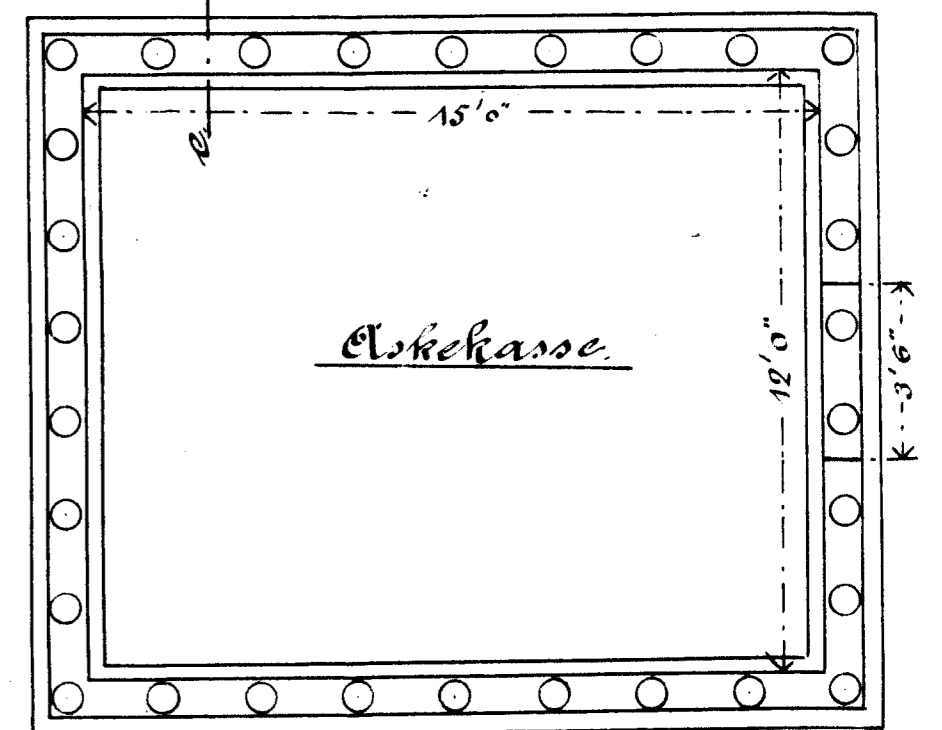
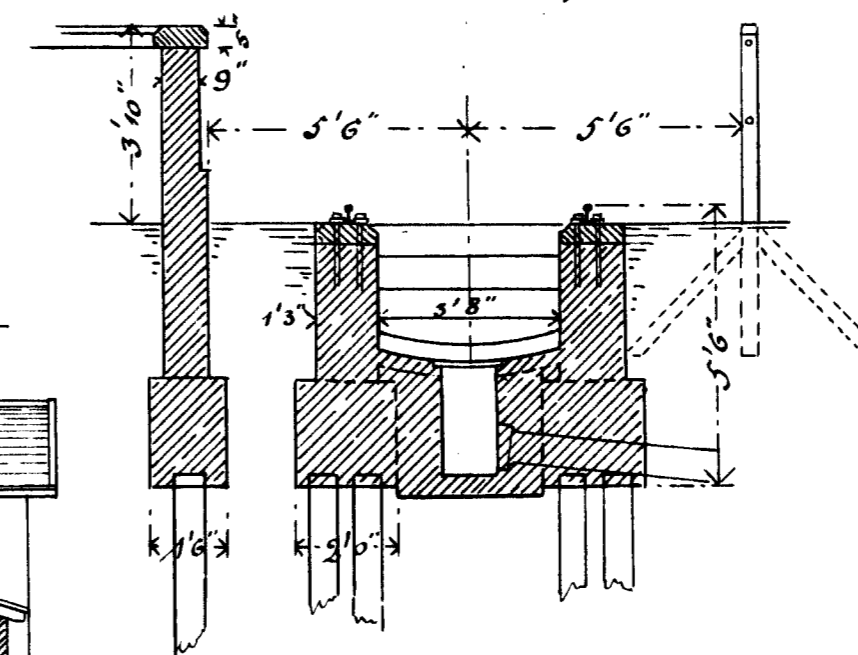

Retiradebygning.

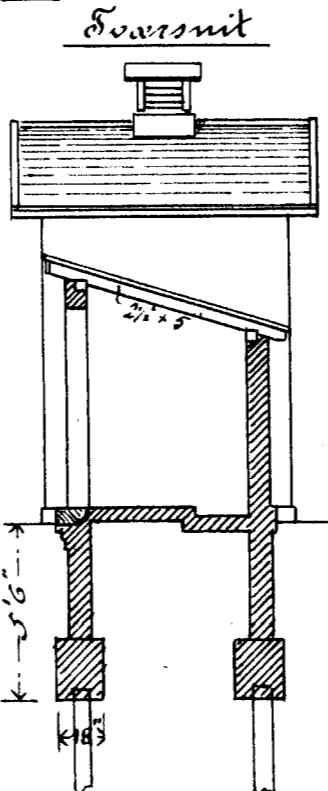
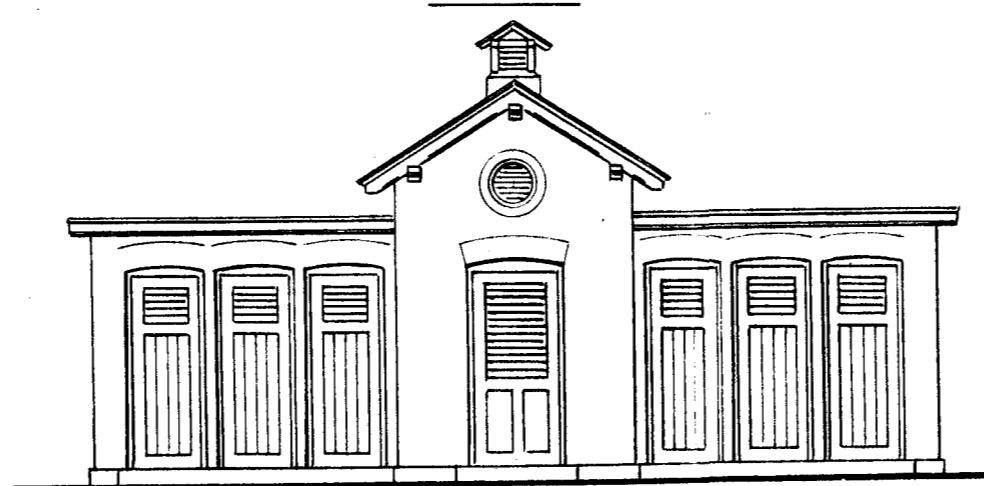

Snit e-d.

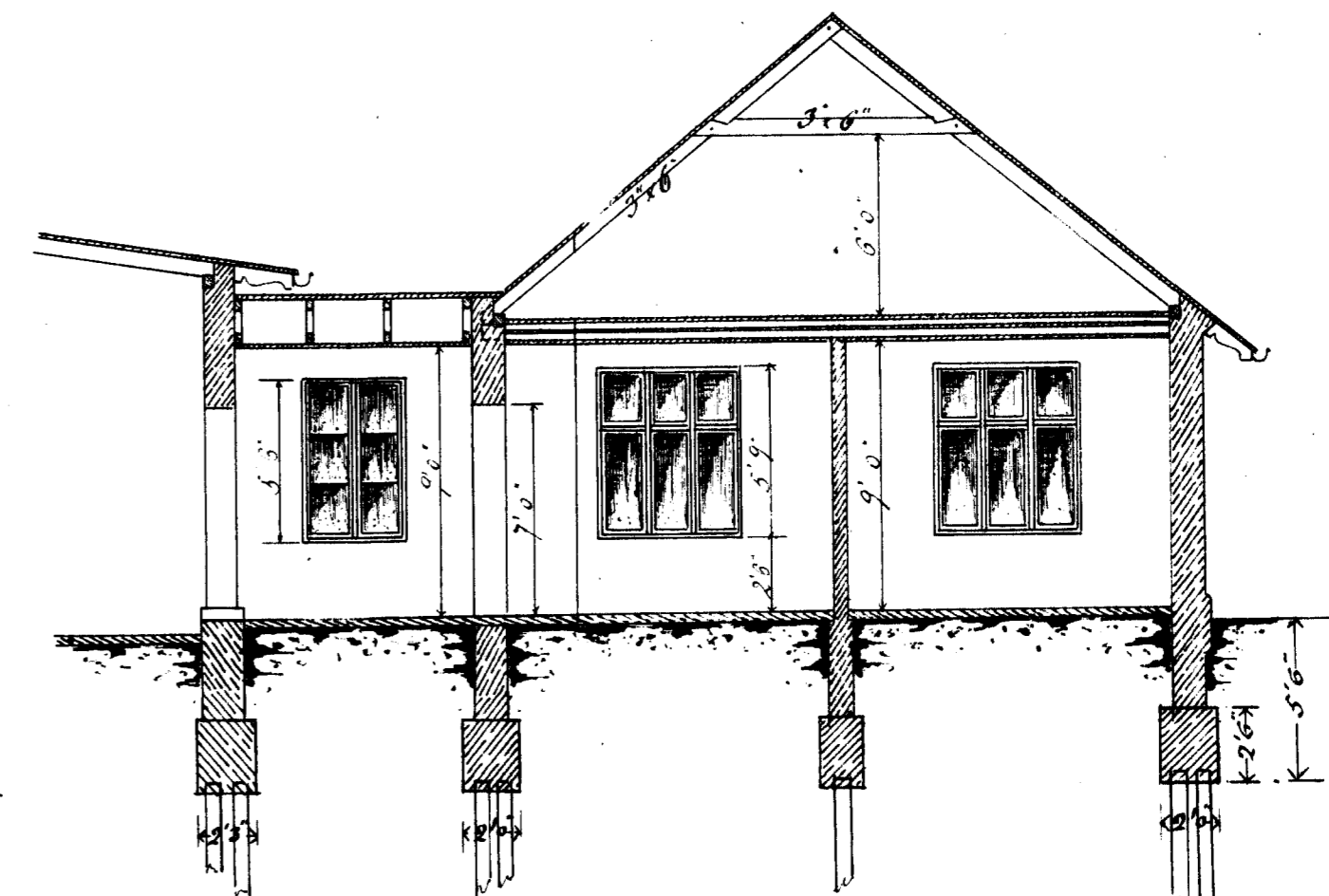

Gærfacade.

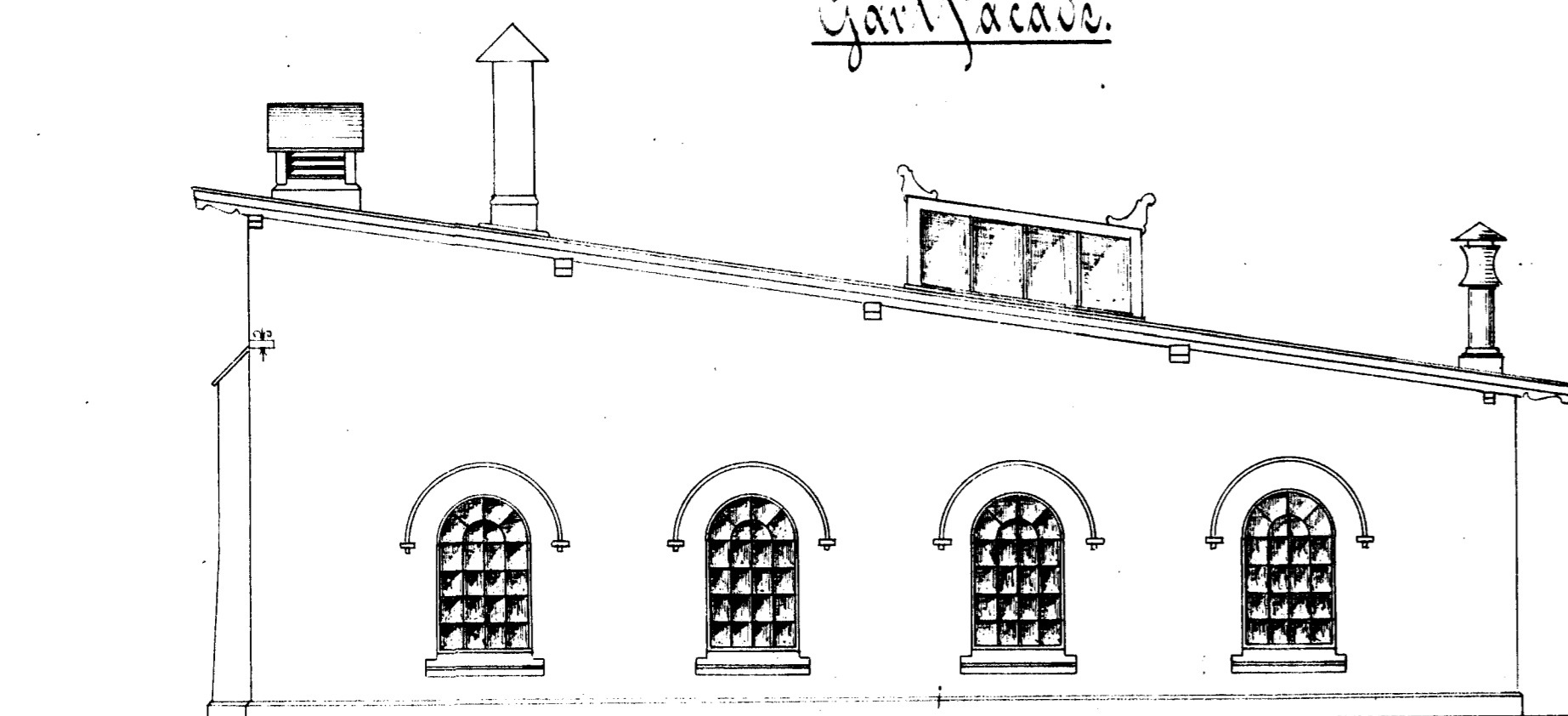

Grundplan.

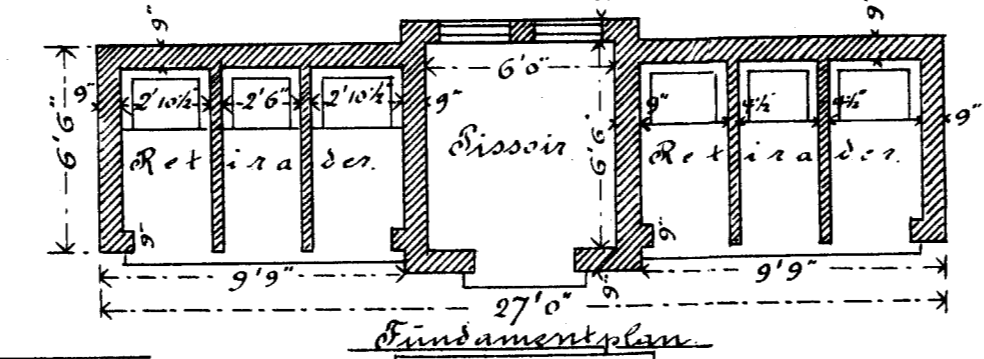

Grundplan.

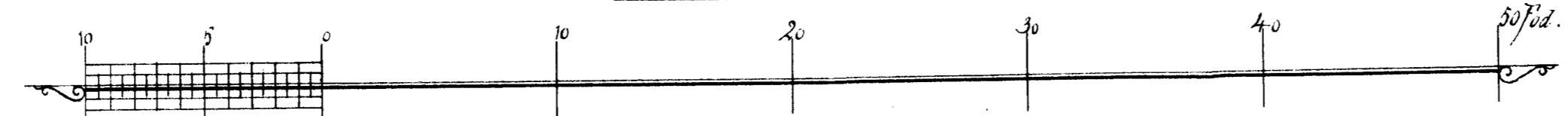
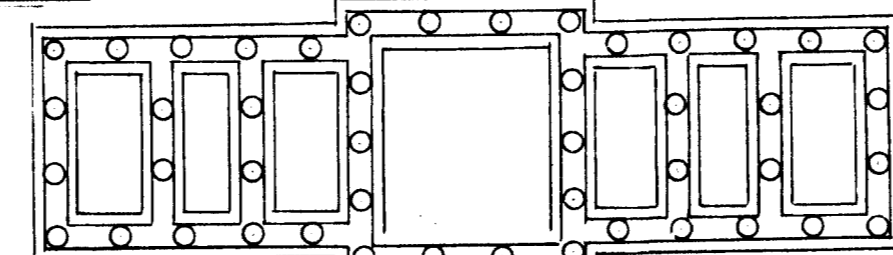

The. Abee.
 Architect