

435  
565  
7000

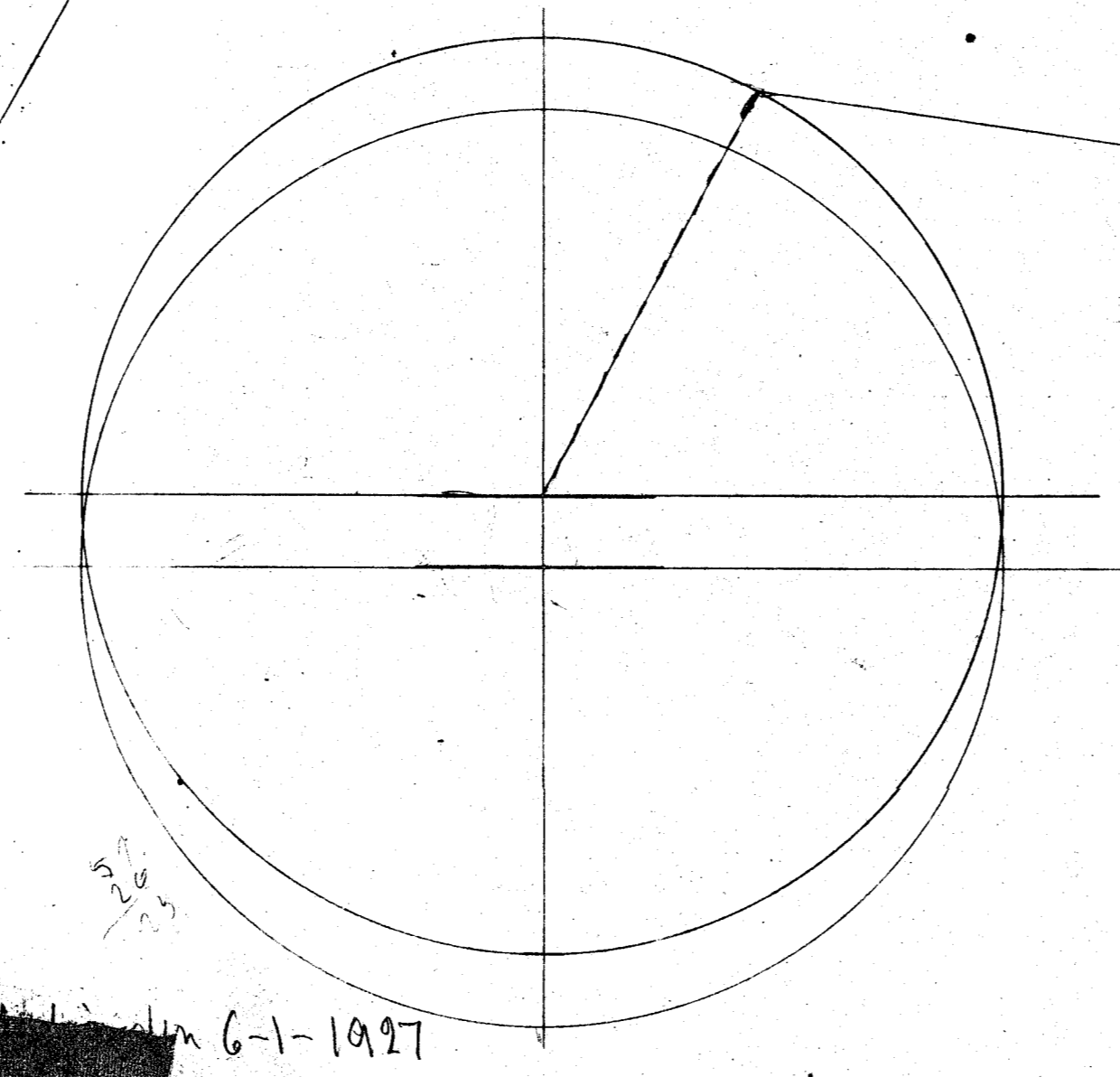

1130  
290  
1420  
500  
2  
1130  
290  
282  
1425  
290  
7877

Drivstang ved fjederbrud.

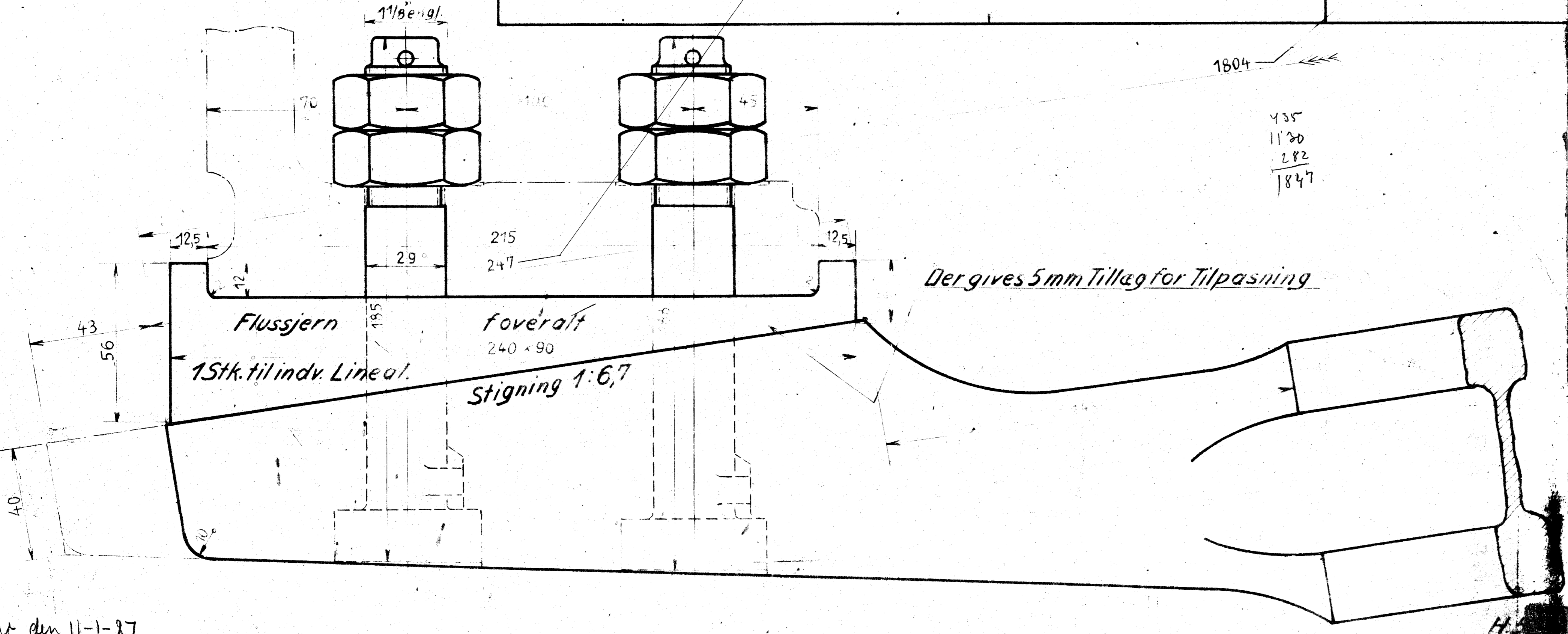
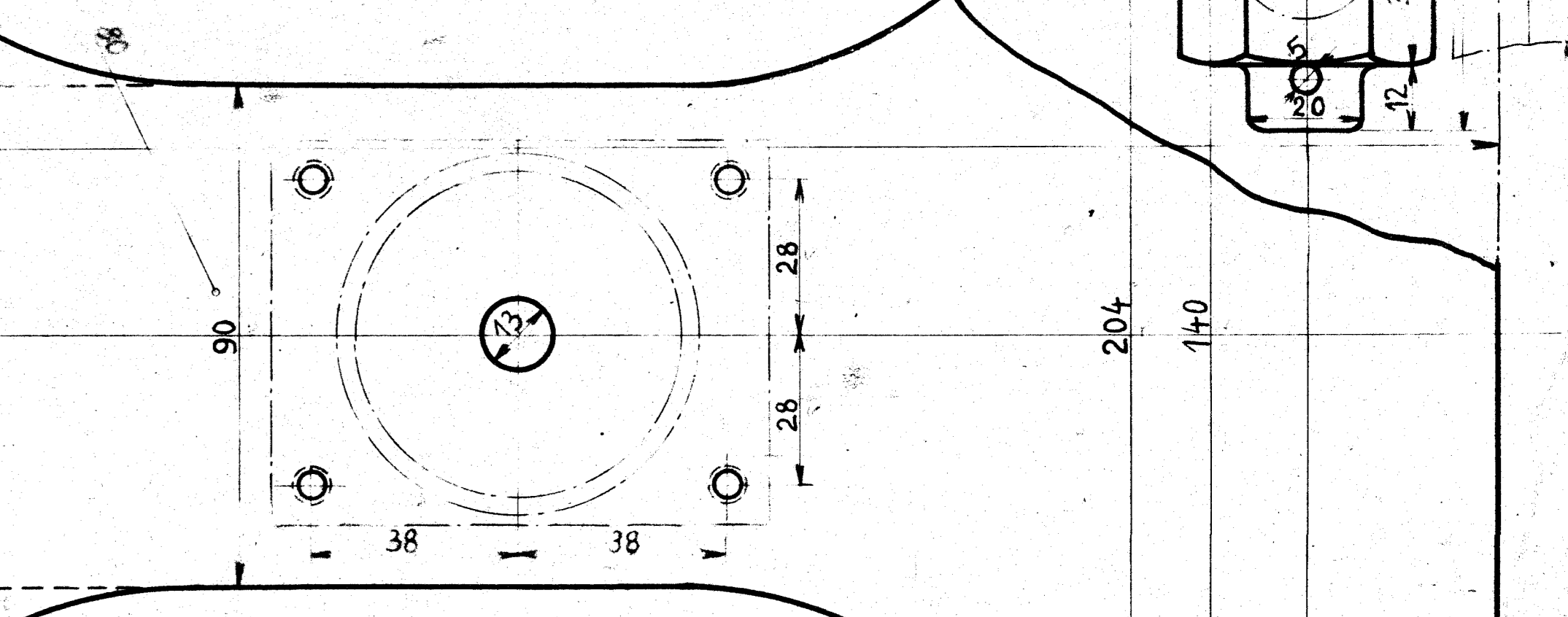
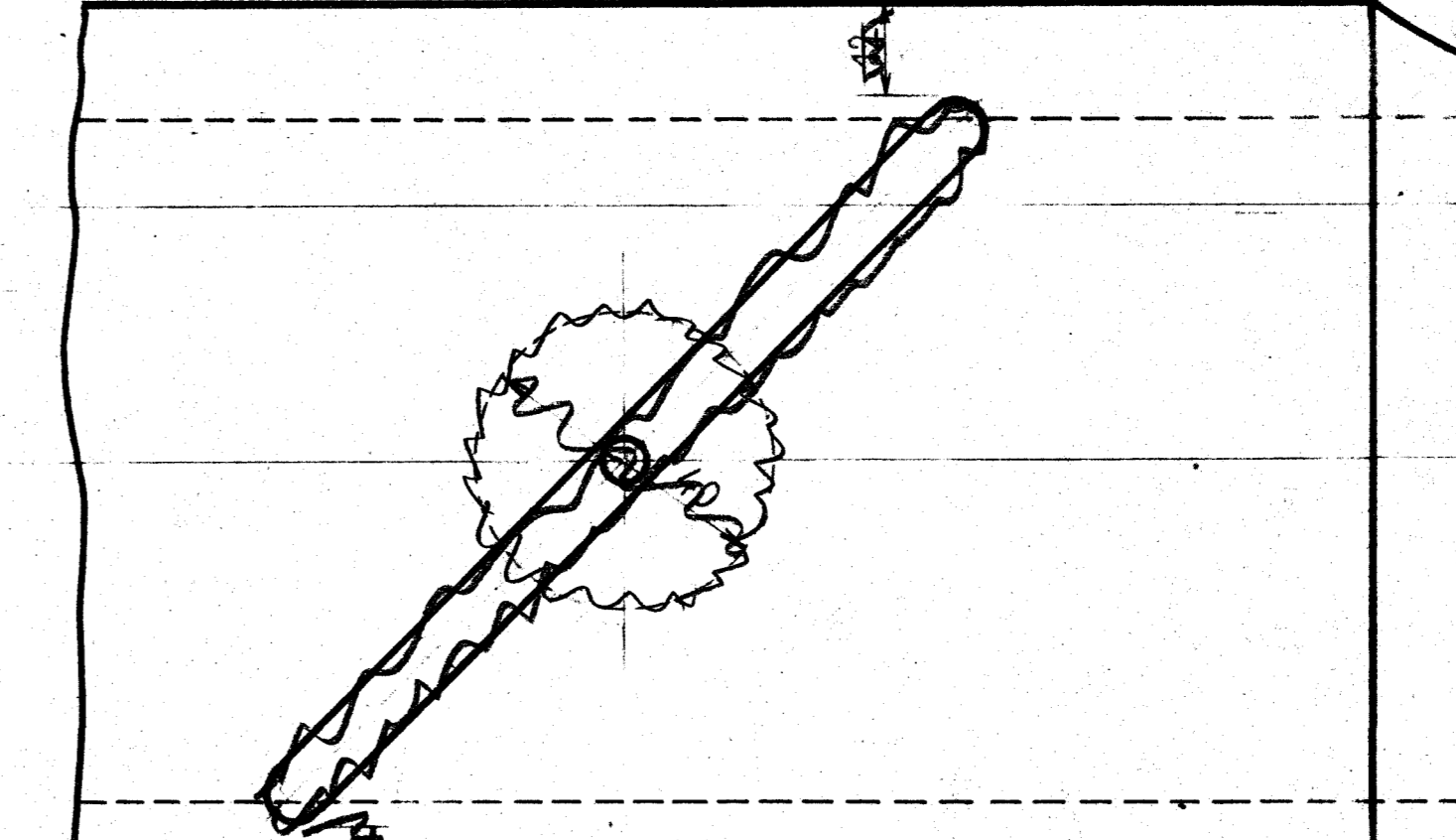
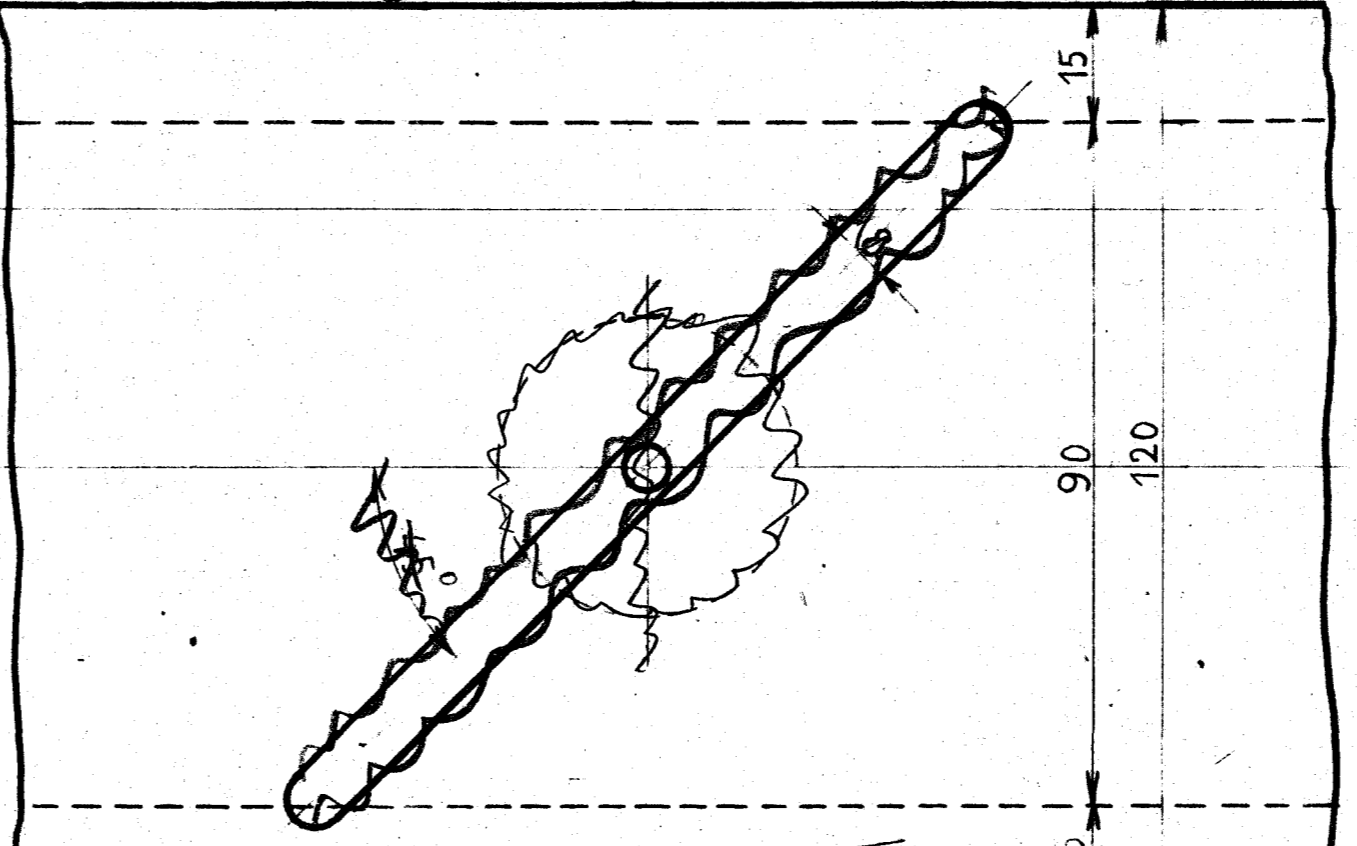
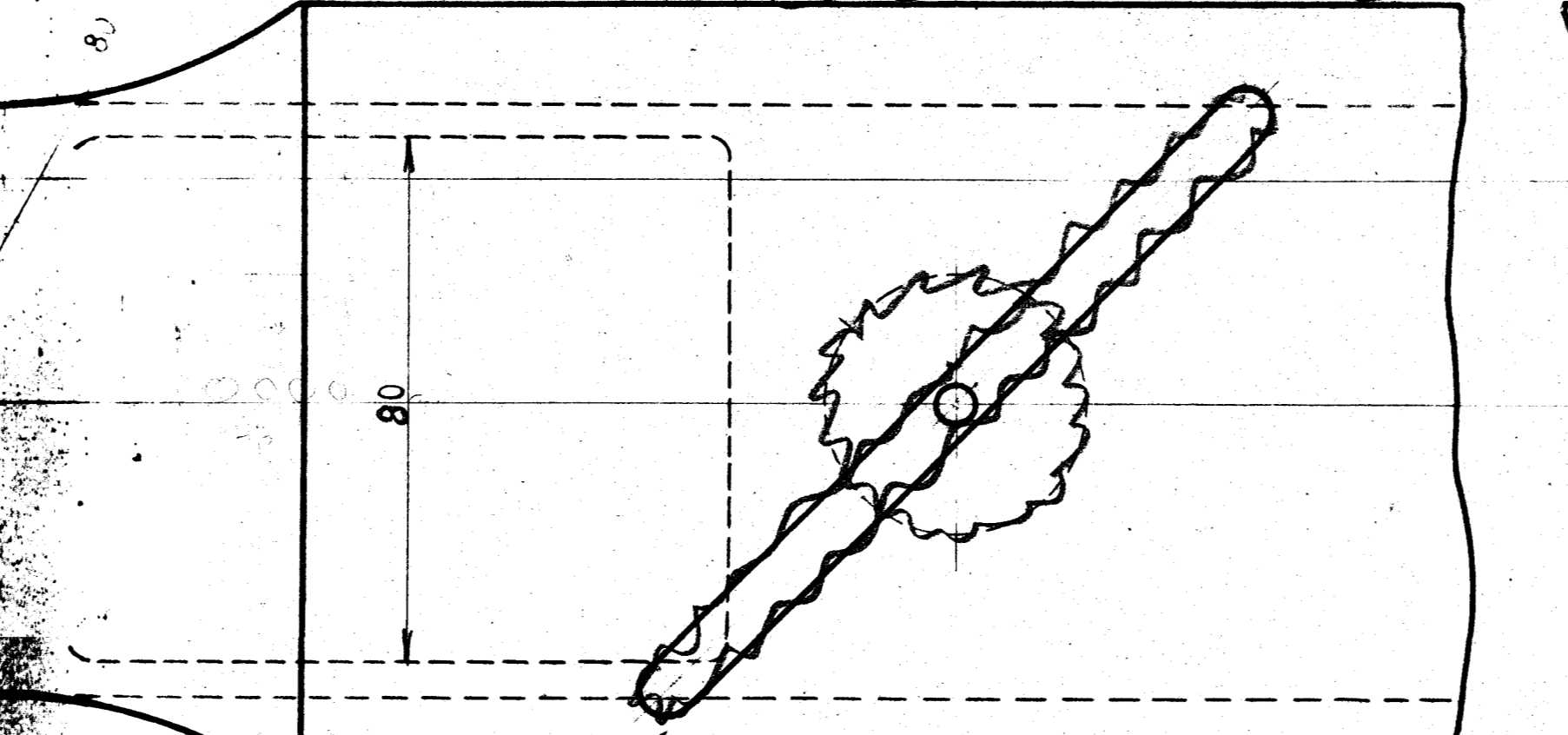
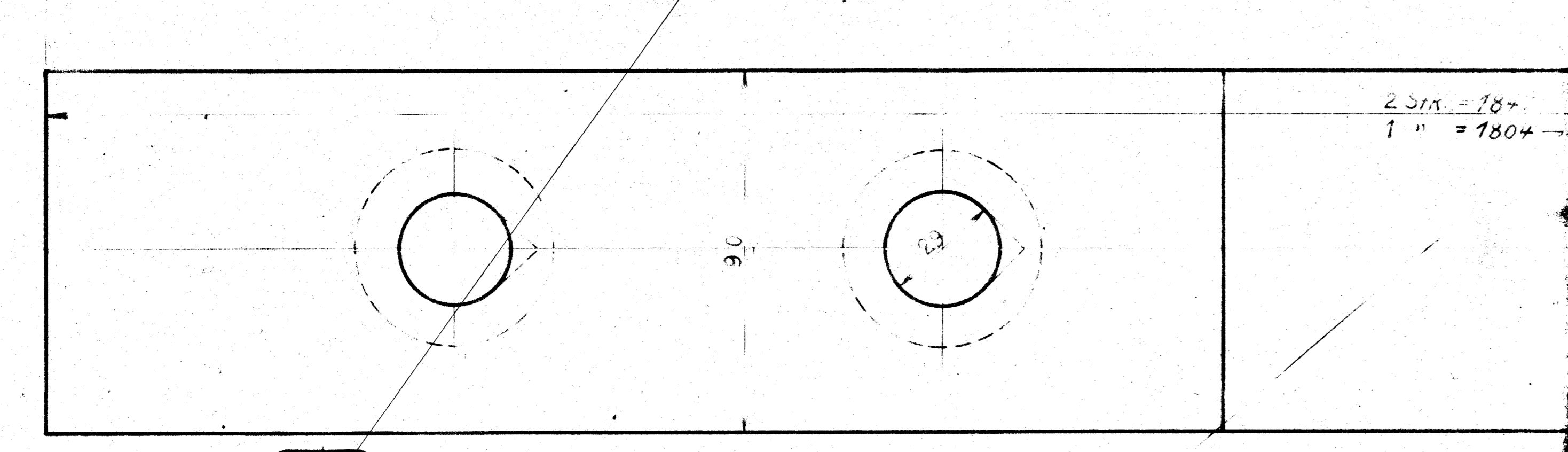
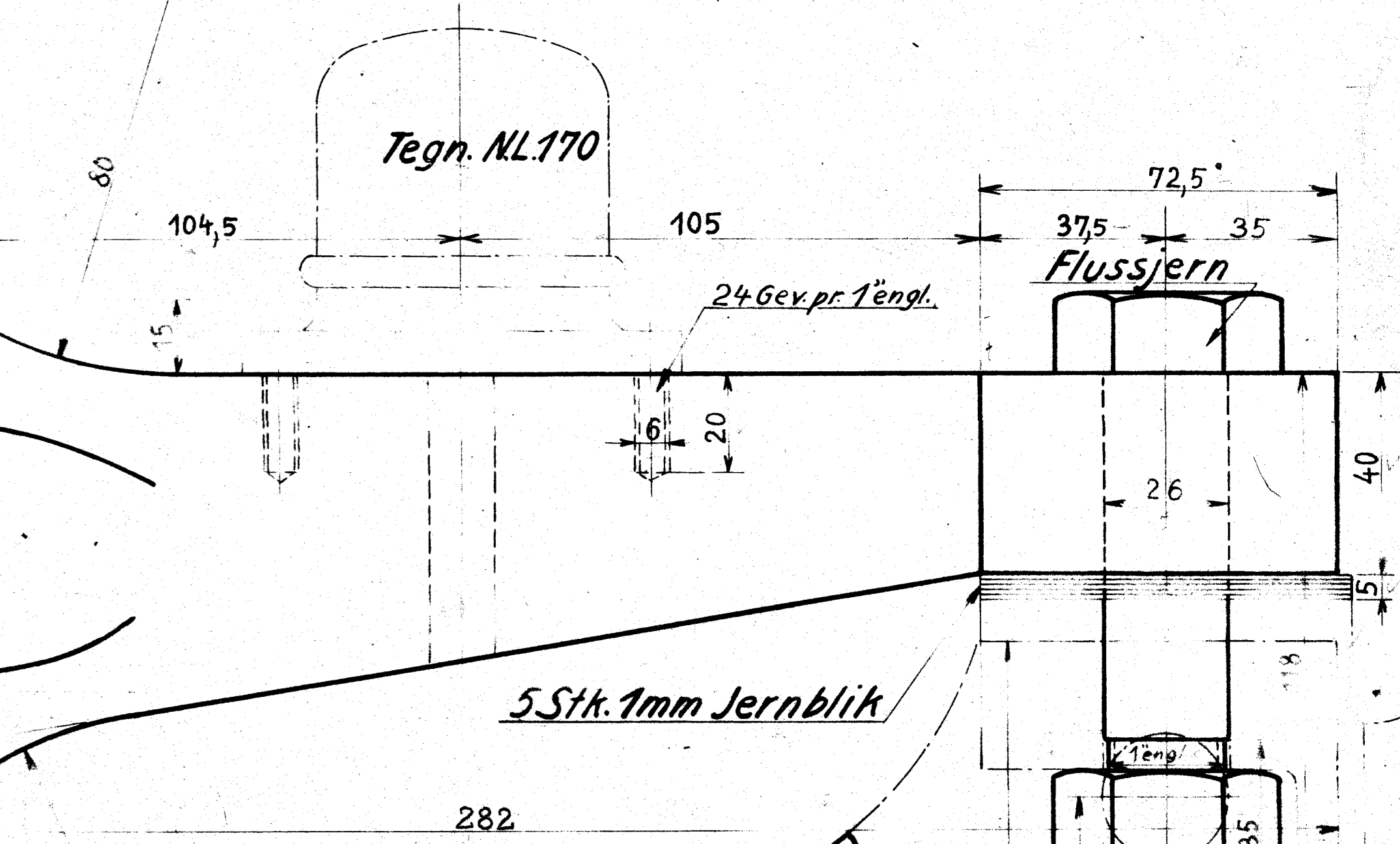
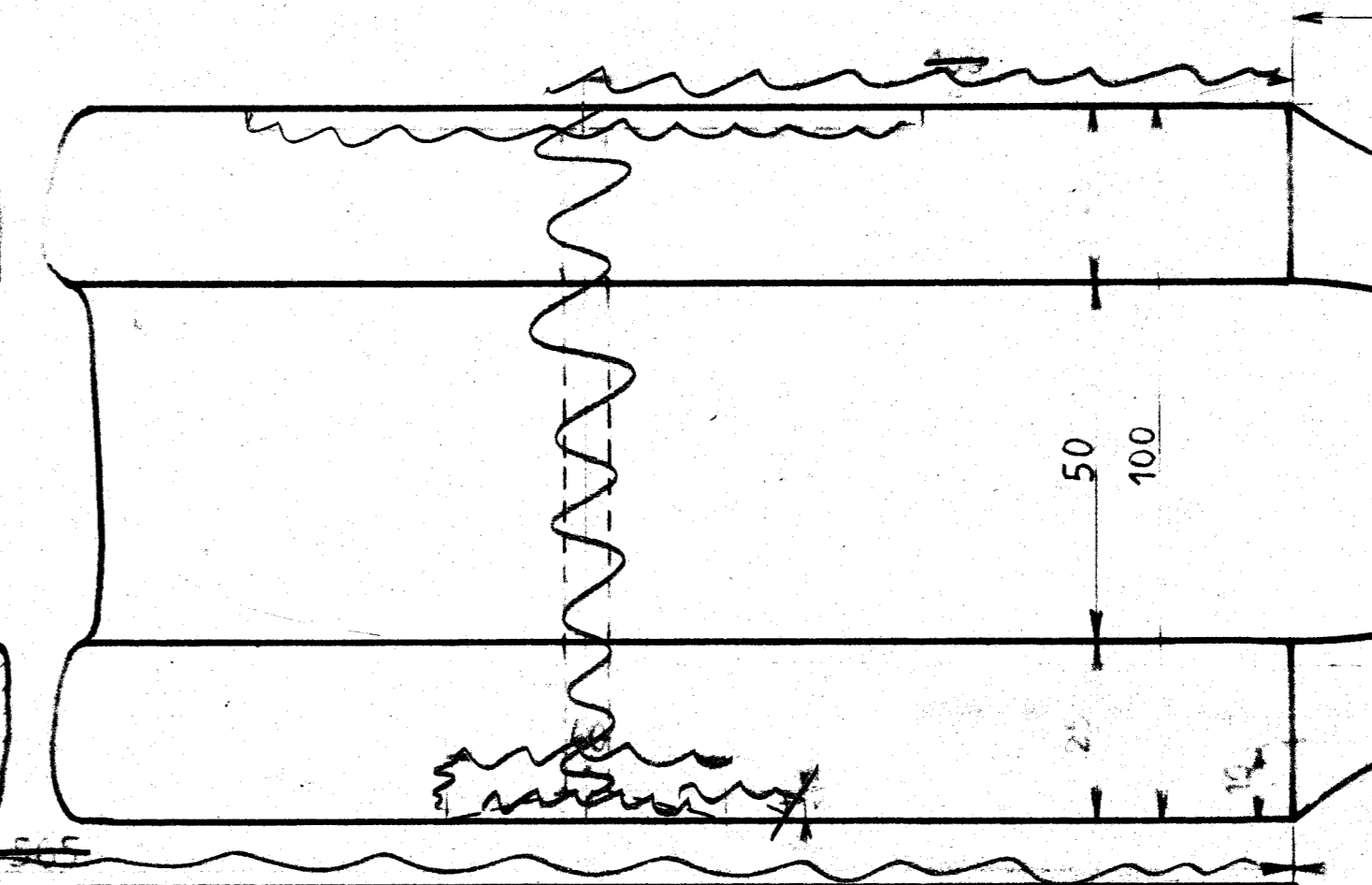
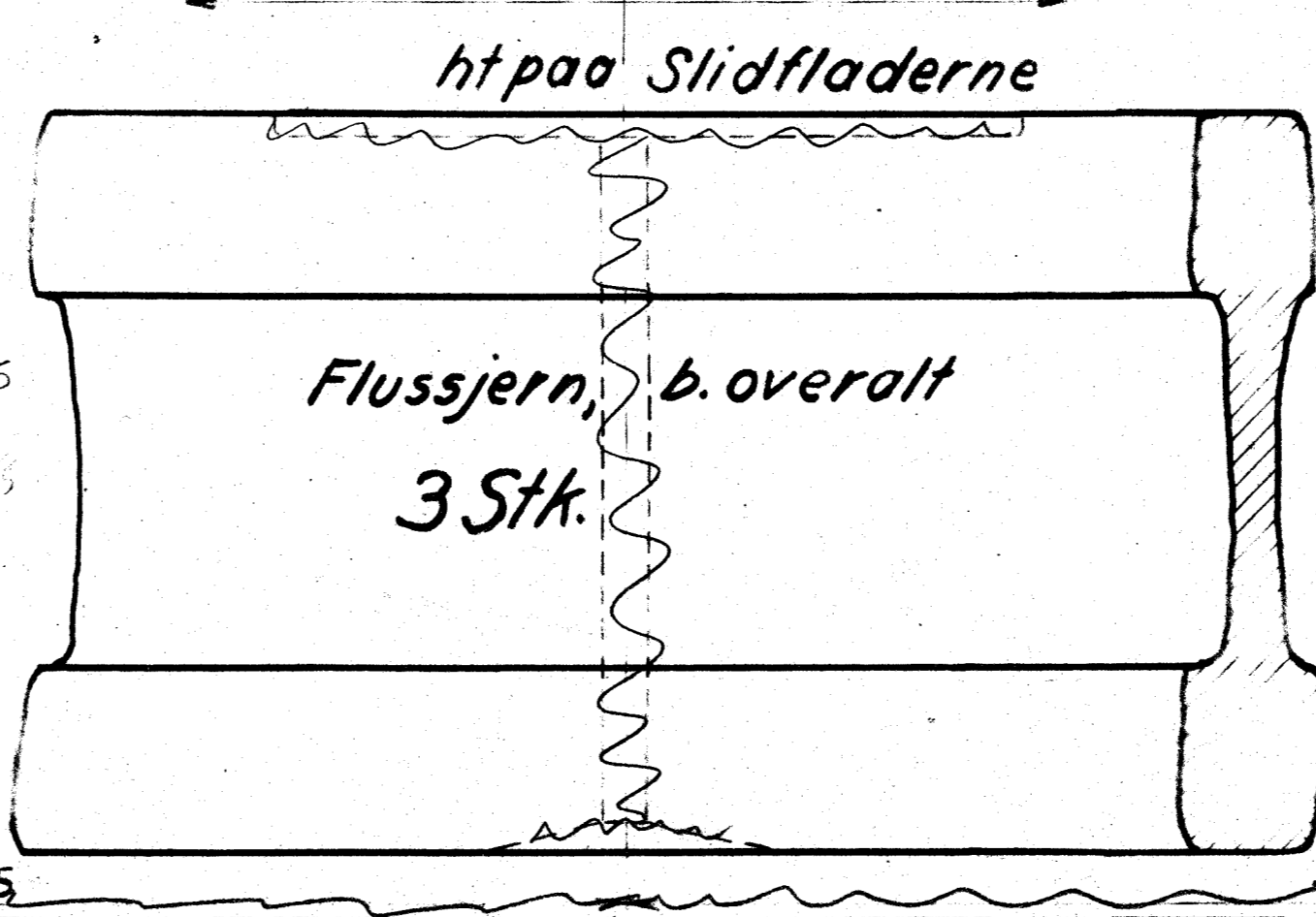
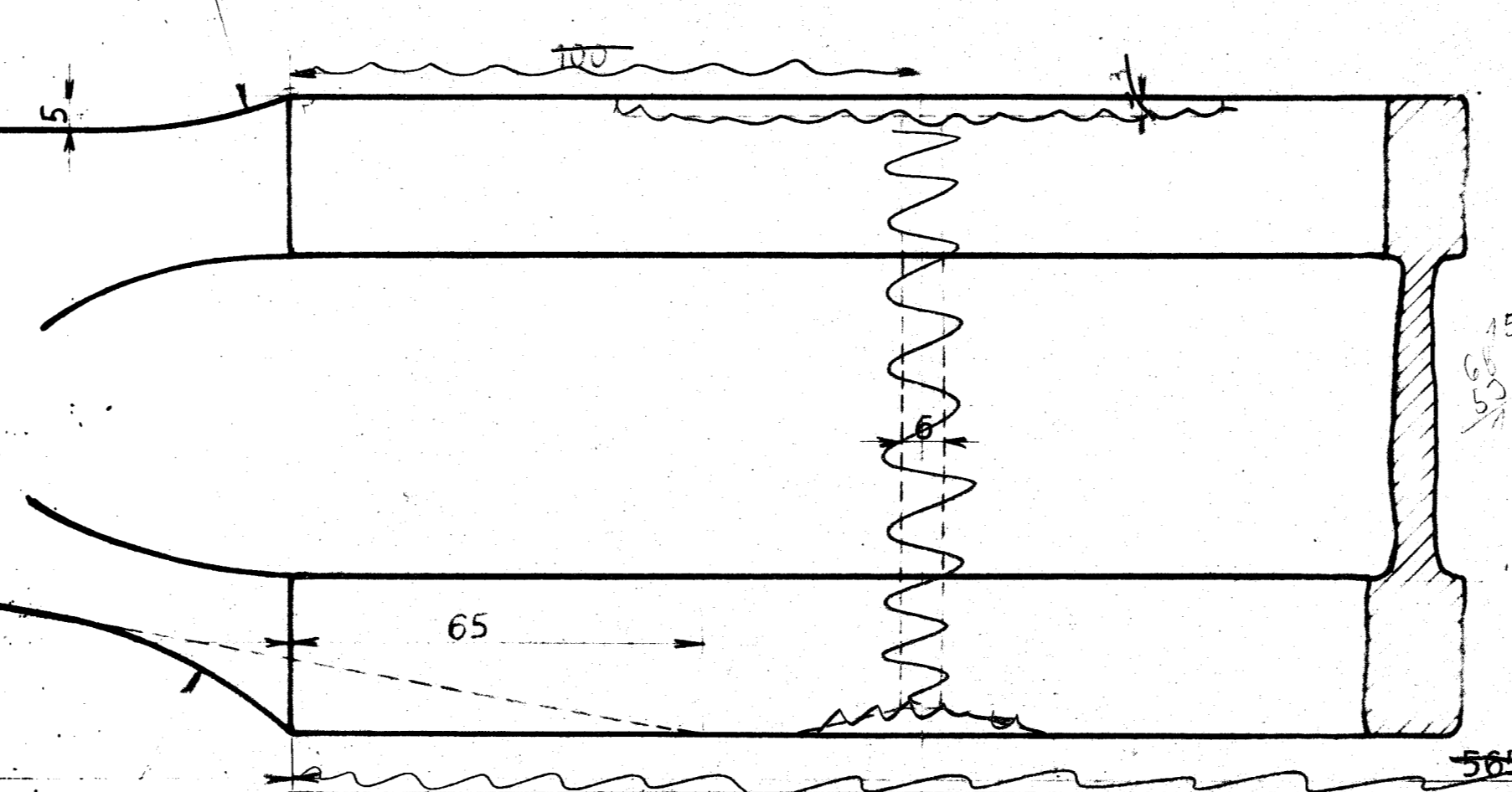
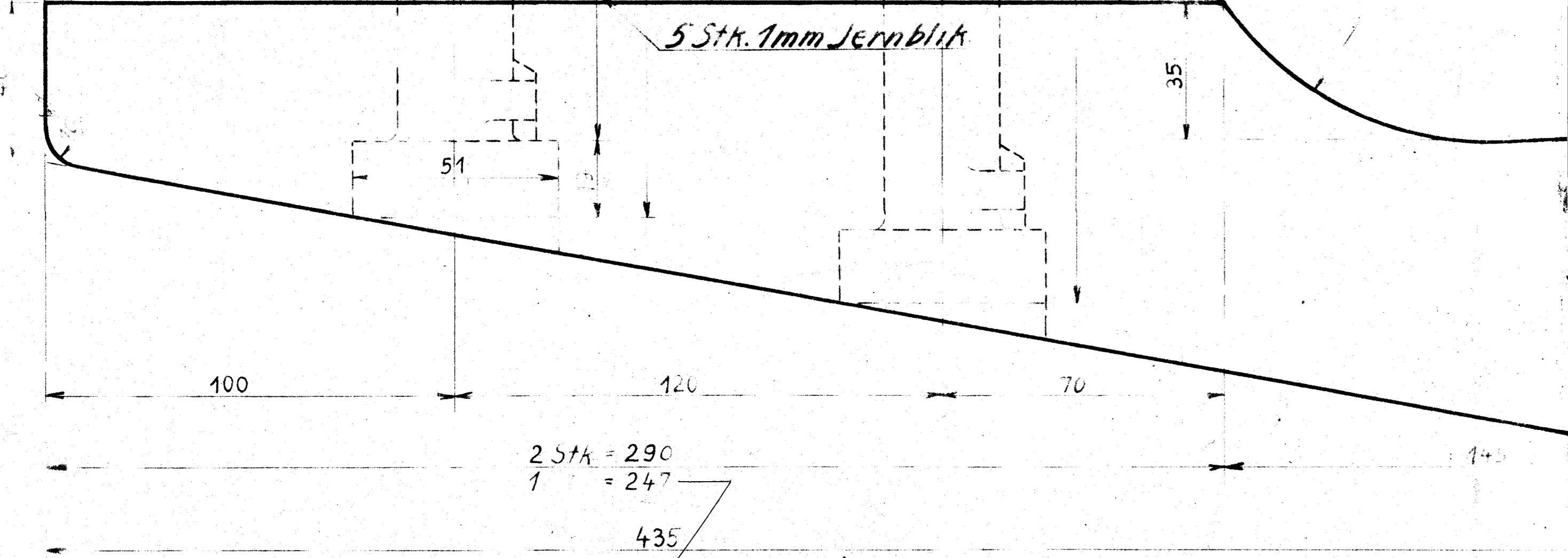
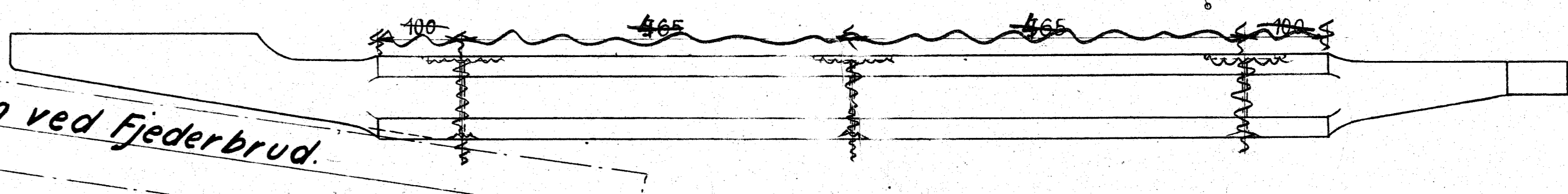

Forandringer		Dato	Mærke
Smørehuller fjernede		19/4/27	V.S.
Kjøbenhavn 1-27		Modelstok	
Tegnet af		1:5	
Hilkeret af		1:1	
Revideret af			

De danske Statsbaner.  
Maskinafdelingen.  
Lineal og Bærevinkel til  
Loko. Litra H.

H.54

Antikr. den 11-1-27.

6-1-1927