

0
1.

LON.
D.S.B.

Bagsiderist
for Loko. A, G_{II}, G_{III}, O.

3.200-1.

Kun for nittet fyrkasse

1945.

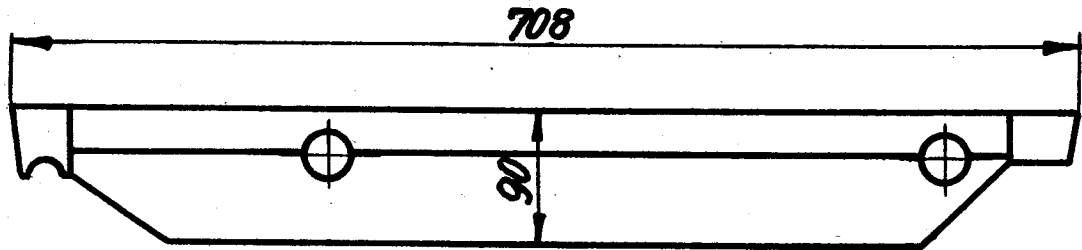

LON. 3.150-5. L = 685/410.

LON. 3.170-2. L = 540/410

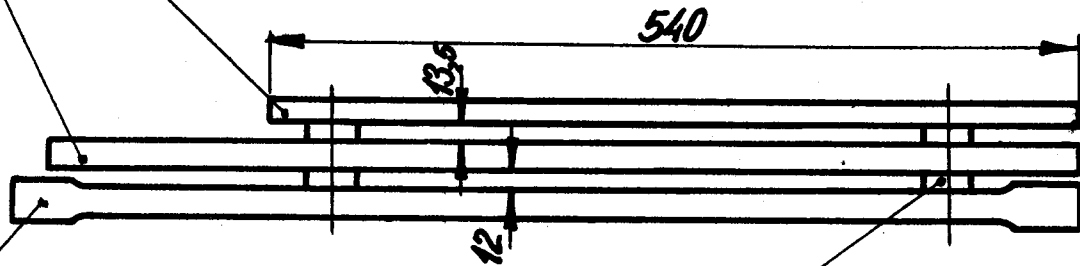

LON. 3.150-2. L = 708/410.

LON. 3.190-1; α = 15.

Venstreudførelse som vist.

Højreudførelse modsat vist

1

| Rekvissionsbetegnelse. | Materiale: | Model Nr. | Mindstebeholdn. |
|---------------------------|------------|-----------|-----------------|
| Bagsiderist. LON. 3.200-1 | Flussjern. | | Kh.: Ar. |

0
1.

LON.
D.S.B.

Bagsiderist
for Loko. C, D_I, D_{II}, D_{III}, K_I, K_{II}, D_F.

3.200-2.

Kun for nittet Fyrkasse.

1945

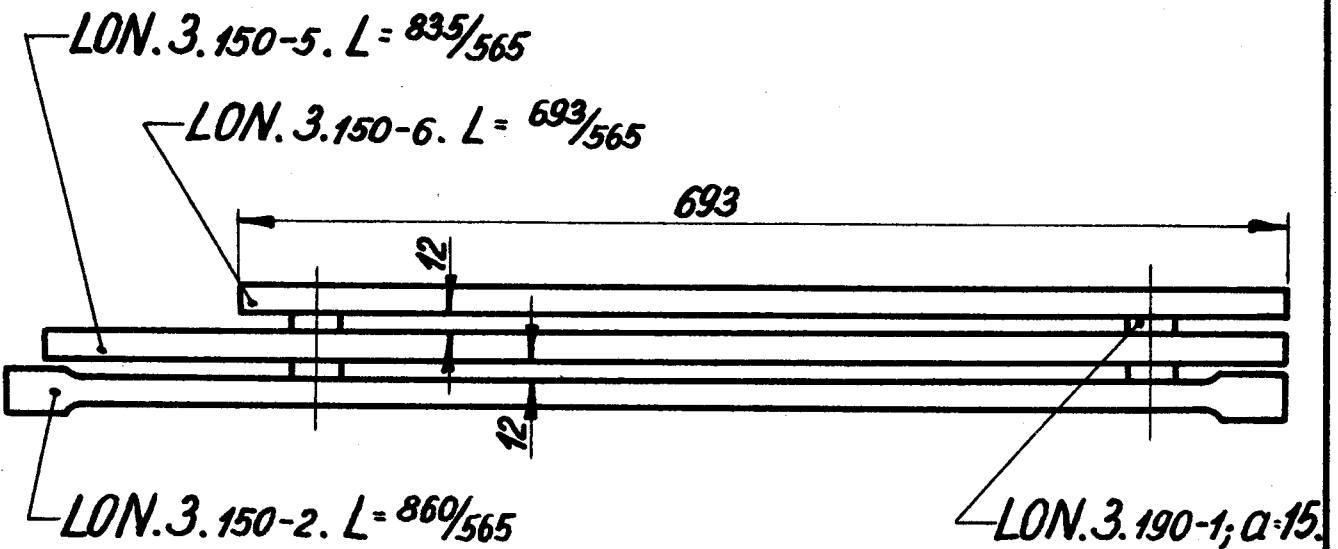
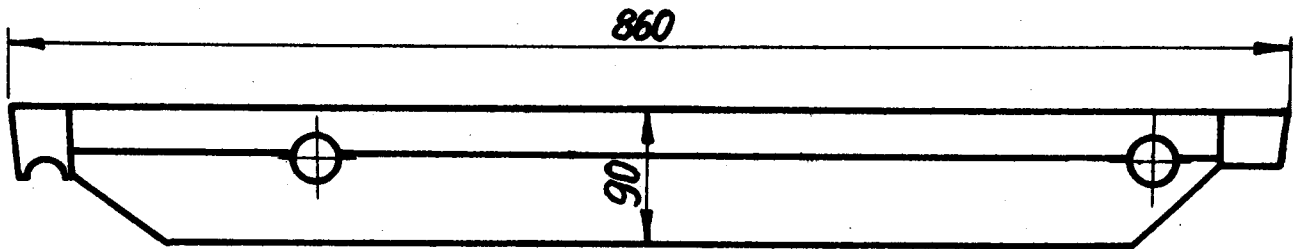

*Venstreudførelse som vist.
Højreudførelse modsat vist.*

2

| Rekvissionsbetegnelse.: | Materiale.: | Model Nr. | Mindstebeholdn. |
|-------------------------|-------------|-----------|-----------------|
| Bagsiderist LON.3.200-2 | Flussjern. | | Kh. Ar. |

01.

LON.
D.S.B.

Bagsiderist
for Loko. C, D_{II}, D_{III}, D_{IV}, K_I, K_{II}, DF.

3.200-3.

Kun for svejst Fyrkasse.

1945

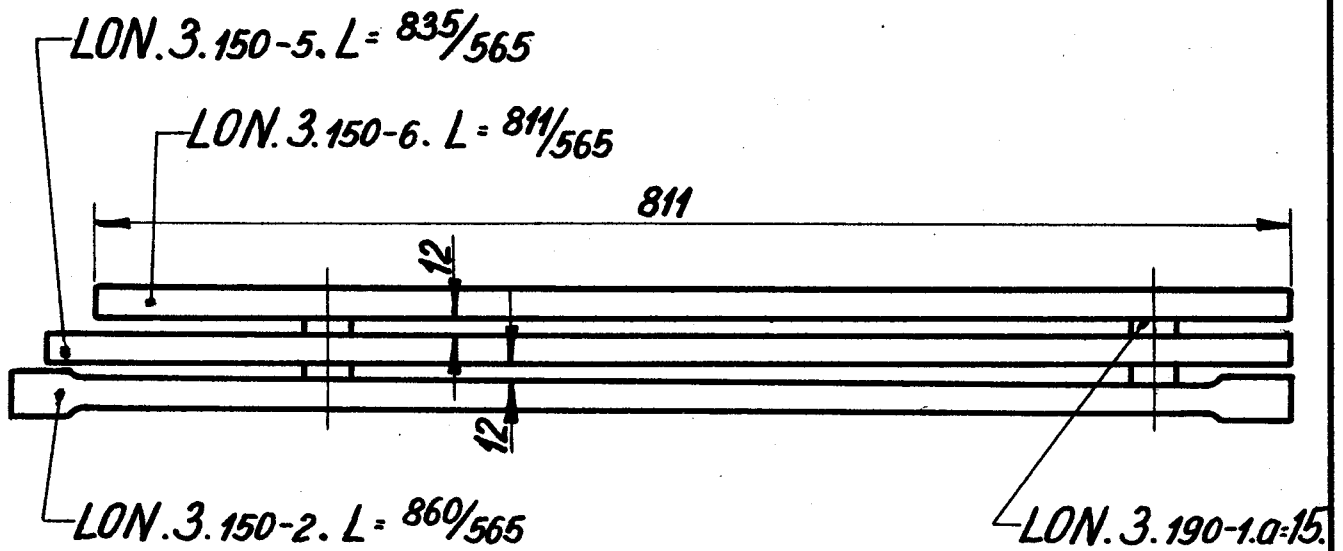
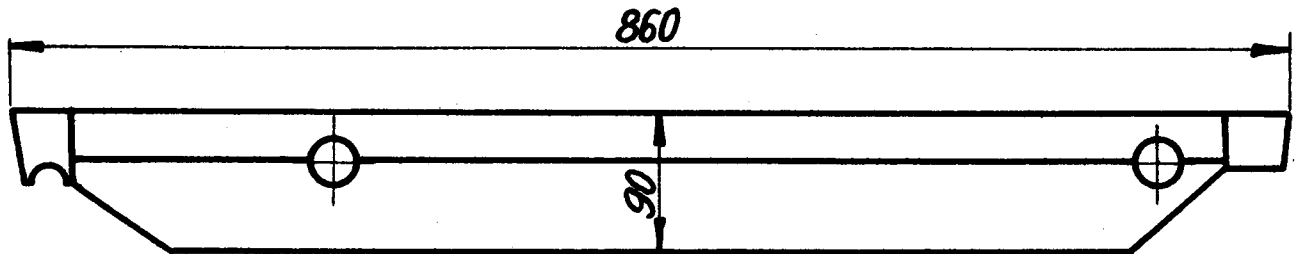

*Venstreudførelse som vist.
Højreudførelse modsat vist.*

3

| Rekvisebetegnelse.: | Materiale. | Model Nr. | Mindstebeholdn. |
|---------------------------|------------|-----------|-----------------|
| Bagsiderist. LON. 3.200-3 | Flussjern. | | Kh.: Ar.: |

0
1.

LON.
D.S.B.

Mellemsiderist.
for Loko. D_{III}, D_{IV}, T

3.200-4.

1945

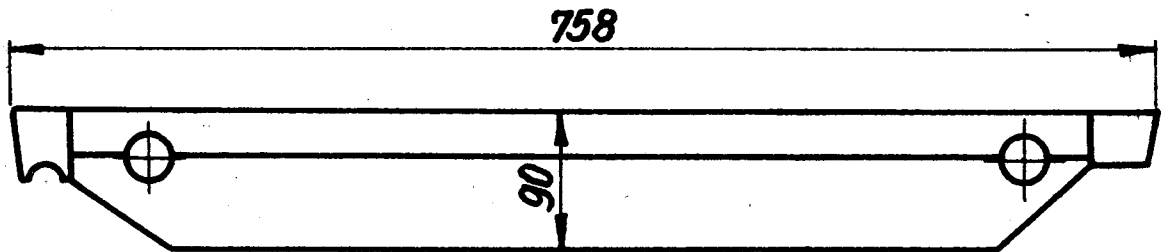

LON. 3.150-4. L = 758/582

LON. 3.150-3. L = 758/582.



LON. 3.150-2. L = 758/582

LON 3.190-1; a = 15.

| Rekvisitionsbetegnelse.: | Materiale. | Model Nr. | Mindstebeholdn. |
|------------------------------|------------|-----------|-----------------|
| Mellemsiderist LON. 3.200-4. | Flussjern. | | Kh.: Ar.: |

4

LON.
D.S.B.

Bagsiderist for Loko. E_I, E_{II}.
Inderste Sæt.

AI
3.200-5.

Kun for smedede ristestænger.

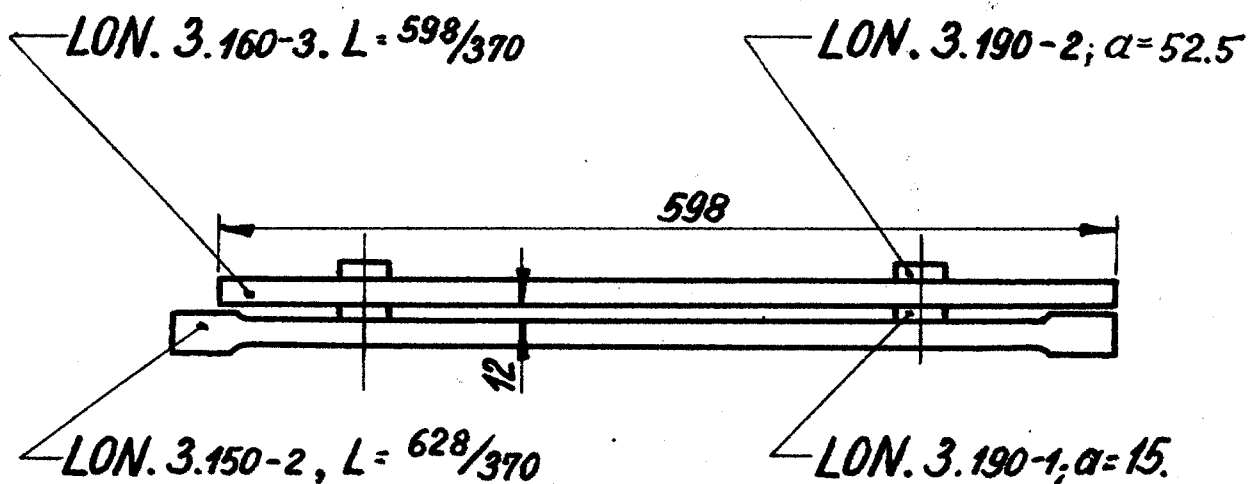
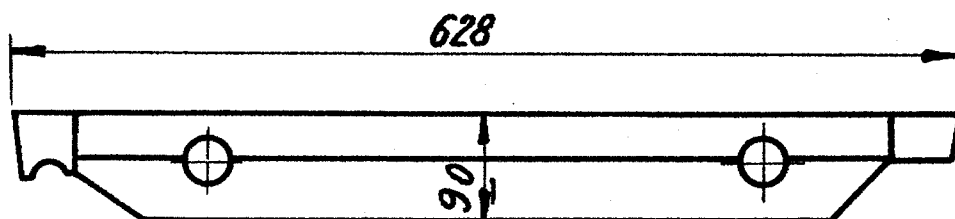

*Venstreudførelse som vist.
Højreudførelse modsat vist.*

1:5

Rekvissionsbetegnelse.:

Materiale.:

Model Nr.

Bagsiderist LON. 3.200-5

Højre
Venstre

St. 34

5

LON.
D.S.B.

Bagsiderist for Loko. E_I, E_{II}.
Yderste Sæt.

A
3.200-6.

1945

Forandringer

LON. 3.150-2 indf. i. h.t. Cvk. Mh. Vkt.
forslag af 22/5-62. A 15.2.63 Damsk.

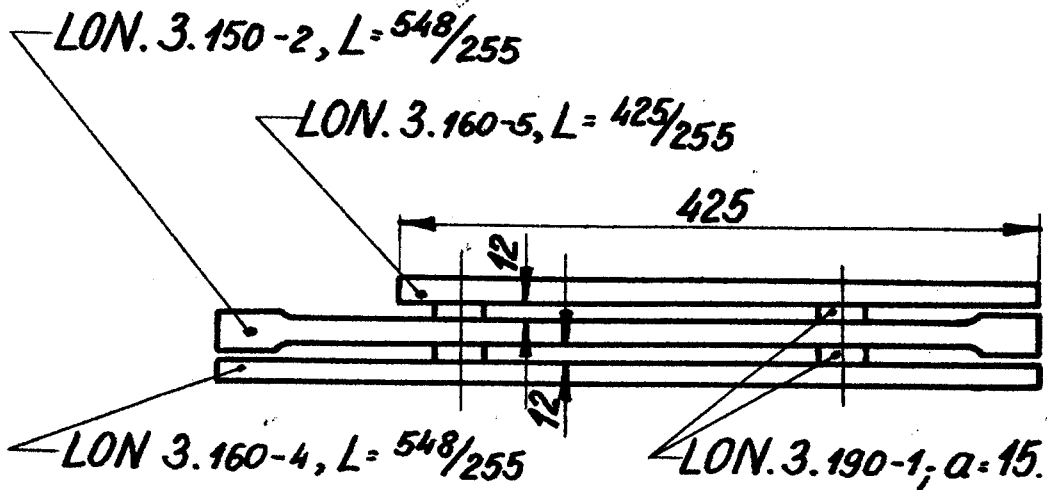
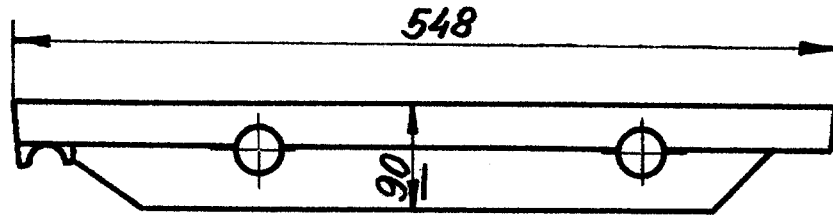

Venstreudførelse som vist.
Højreudførelse modsat vist.

1:5

| Rekvissionsbetegnelse: | Materiale. | Model Nr. | |
|-------------------------|------------|-----------|--|
| Bagsiderist LON.3.200-6 | St. 34 | | |

6

Højre el.
Venstre

LON.
D.S.B.

Mellemsiderist
for Loko E_I, E_{II}

AI
3.200-7.

Kun for smedede ristestænger.

1945

Forandringer

LON 3.150-2 indført i h.1 Cvk. 114. Vkt.
forslag af 22/5-62 A 15.2.63

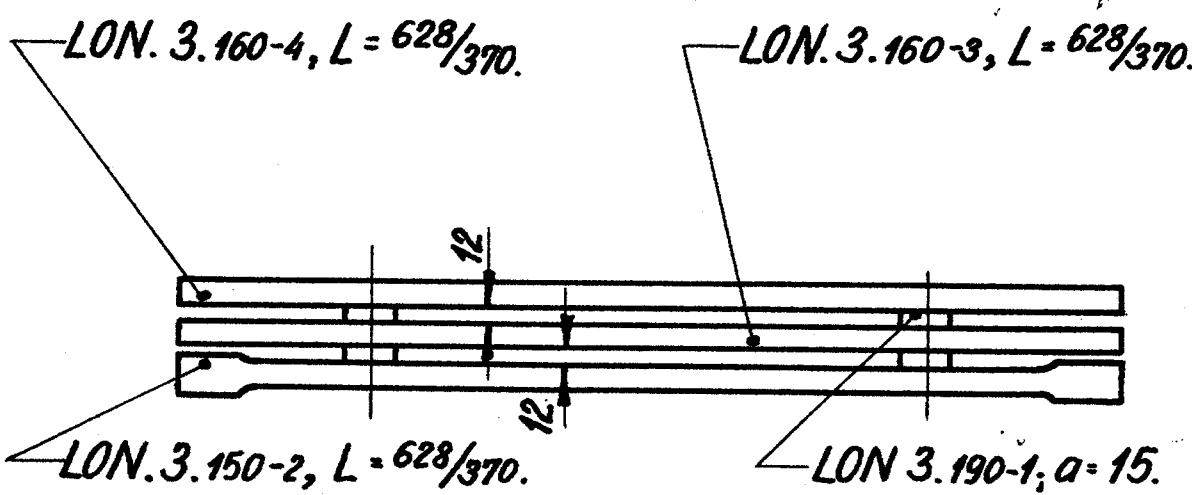
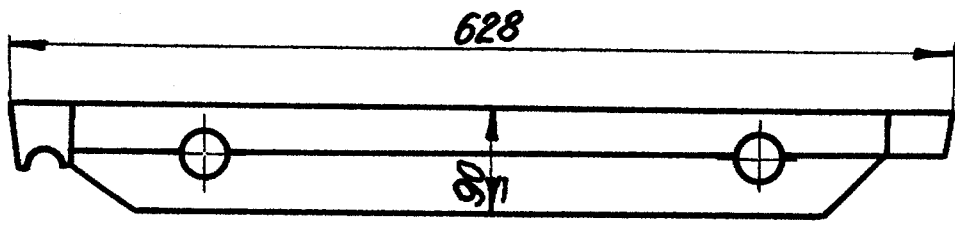

1:5

| | | | |
|---|--------------------|------------|--|
| Rekvissionsbetegnelse.: Mellemsiderist LON.3.200-7. | Materiale.: St. 34 | Model Nr.: | |
|---|--------------------|------------|--|

7

0.
1.LON.
D.S.B.Mellemsiderist
for Loko E_I, E_{II}

3.200-7.

Kun for smedede ristestænger.

1945

LON. 3.160-4, $L = 628/370$.LON. 3.160-3, $L = 628/370$.LON. 3.160-2, $L = 628/370$.LON 3.190-1, $a = 15$.

Rekvisitionsbetegnelse.: Materiale.: Model Nr.: Mindstebehold.

Mellemsiderist LON.3.200-7. Flussjern. Kh.: Ar:

7

0

LON.
D.S.B.Bagsiderist.
for Loko F_{II} , F_{III} , J_{II} .

3.200-8.

Kun for mittet Fyrkasse.

1945

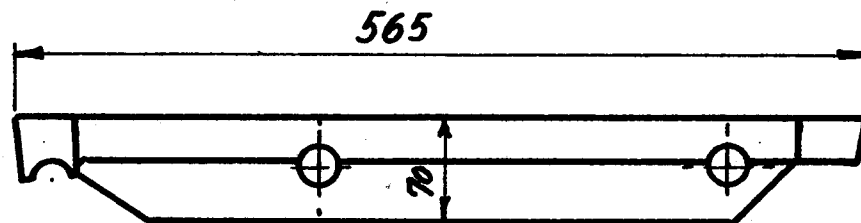
LON 3.160-3, $L = 545/270$ LON 3.170-2, $L = 460/270$ LON 3.190-1, $a = 15$.LON 3.160-2, $L = 565/270$ LON 3.190-1, $a = 15$

Venstreudførelse som vist.

Højre ——— modsat .

Rekvissionsbeleggnelse

Materiale

Model Nr

Mindstebeholdn

Bagsiderist LON 3.200-8

højre
venstre

Flussjern

Kh

Ar.

1

a.
1.

LON.
D.S.B.

Bagsiderist
for Loko F_{II} - AF_{II} 123-126

3.200-9.

Kun for svejst Fyrkasse

1945

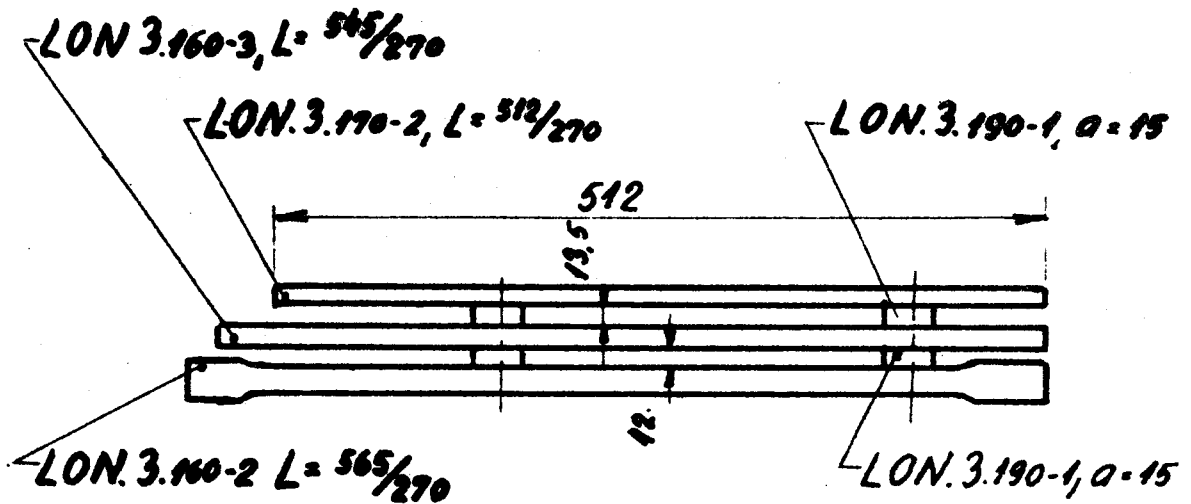
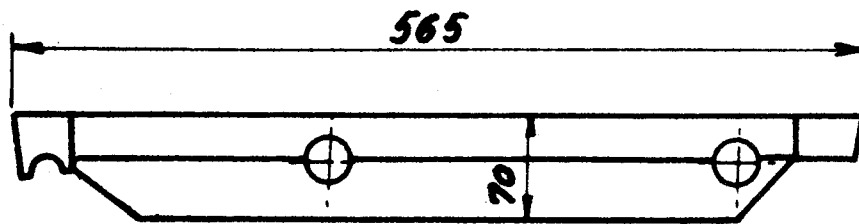

Venstredførelse som vist

Højre ——— . ——— modsat .

2

| Rekvisitionsbetegnelse | Materiale | Model Nr. | Mindstebeholdn. |
|------------------------|-----------|-----------|-----------------|
| Bagsiderist LON.3200-9 | Flussjern | | Kh. Ar. |

0.

LON.
D.S.B.

Bagsiderist
for Loko H_I, H_{II}, R_I, R_{II}

3.200-10.

1945

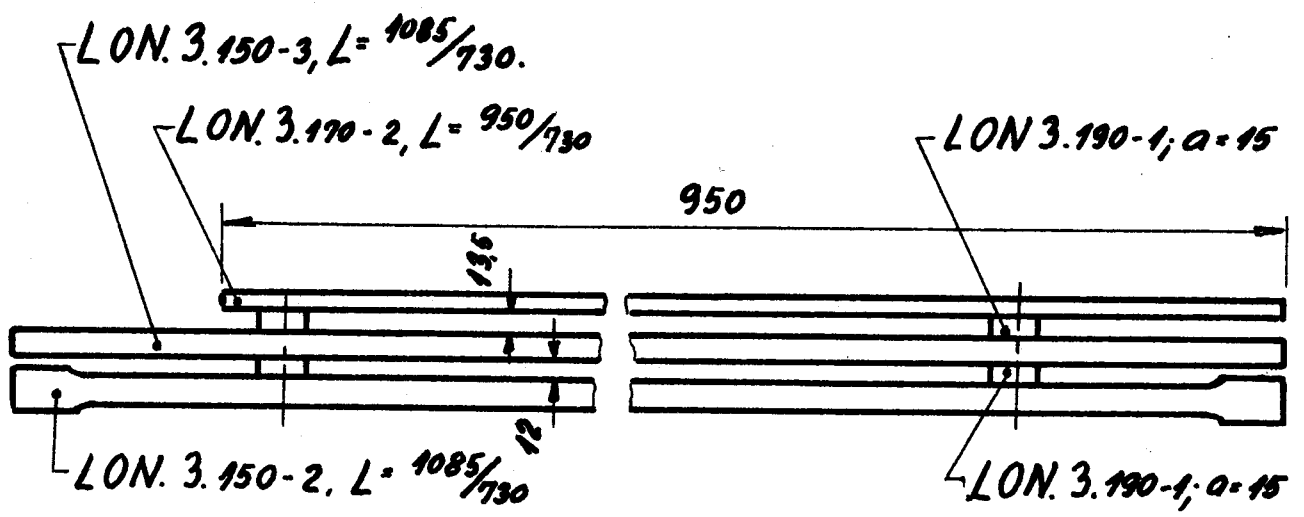
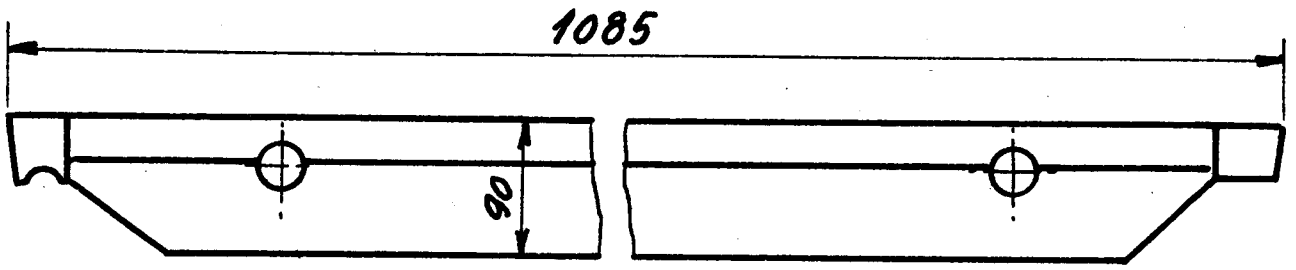

Venstredførelse som vist
Højre ——— modsat •

3

| Rekvissionsbetegnelse | Materiale. | Model Nr | Mindstebeholdn. |
|---|------------|----------|-----------------|
| Bagsiderist LON.3.200-10 { højre el. venstre. | Flussjern. | | Kh. Ar. |

0.

| | | |
|----------------|--|-----------|
| LON. D.S.B. | Mellemsiderist for Loko H _I , H _{II} , R _I , R _{II} | 3.200-11. |
|----------------|--|-----------|

1945

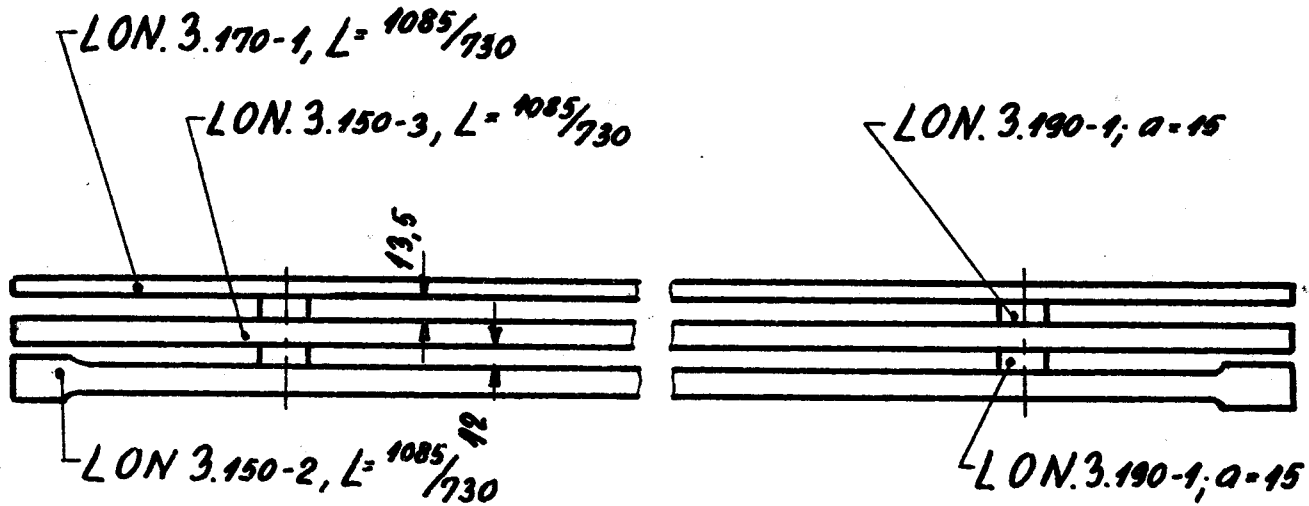
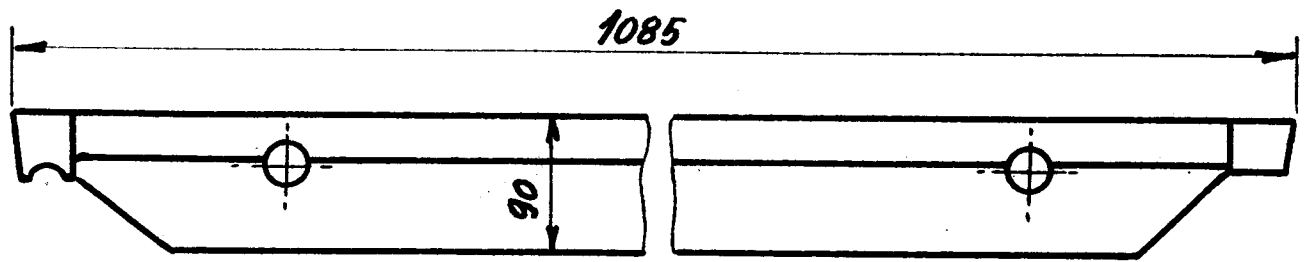

| Rekvissionsbetegnelse | Materiale | Model Nr. | Mindstebeholdn | |
|------------------------------|------------|-----------|----------------|-----|
| Mellemsiderist LON. 3.200-11 | Flussjern. | | Kh. | Ar. |

4

0.
1.LON.
D.S.B.Bagsiderist
for Loko Hs_{II}

3.200-12.

Kun for nittet fyrkasse

1945

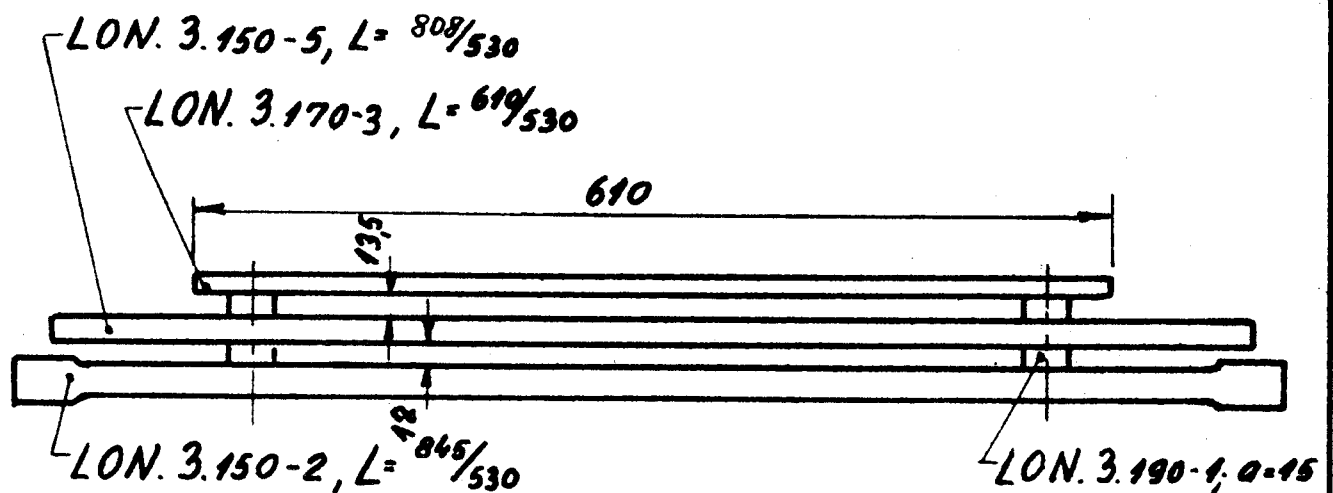
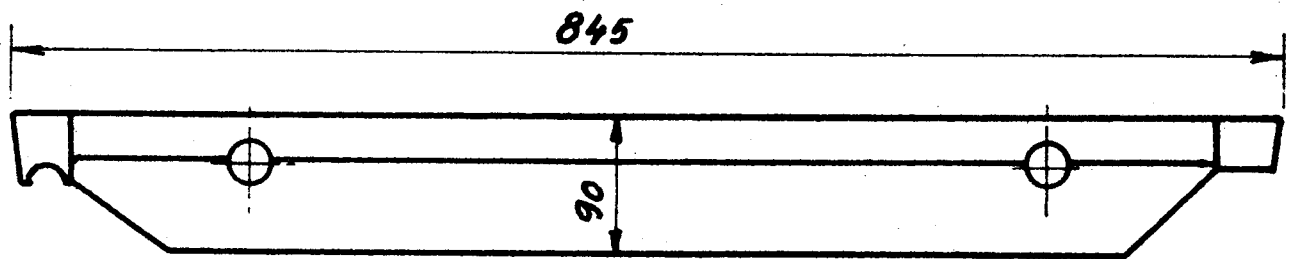

| Rekvissionsbetegnelse | Materiale | Model Nr | Mindstebeholdn |
|---------------------------|------------|----------|----------------|
| Bagsiderist LON. 3.200-12 | Flussjern. | | Kh. Ar. |

5

0
1.

LON.
D.S.B.

Bagsiderist
for Loko P_I, P_{II}.

3.200-13.

Kun for smedede ristestænger.

1945

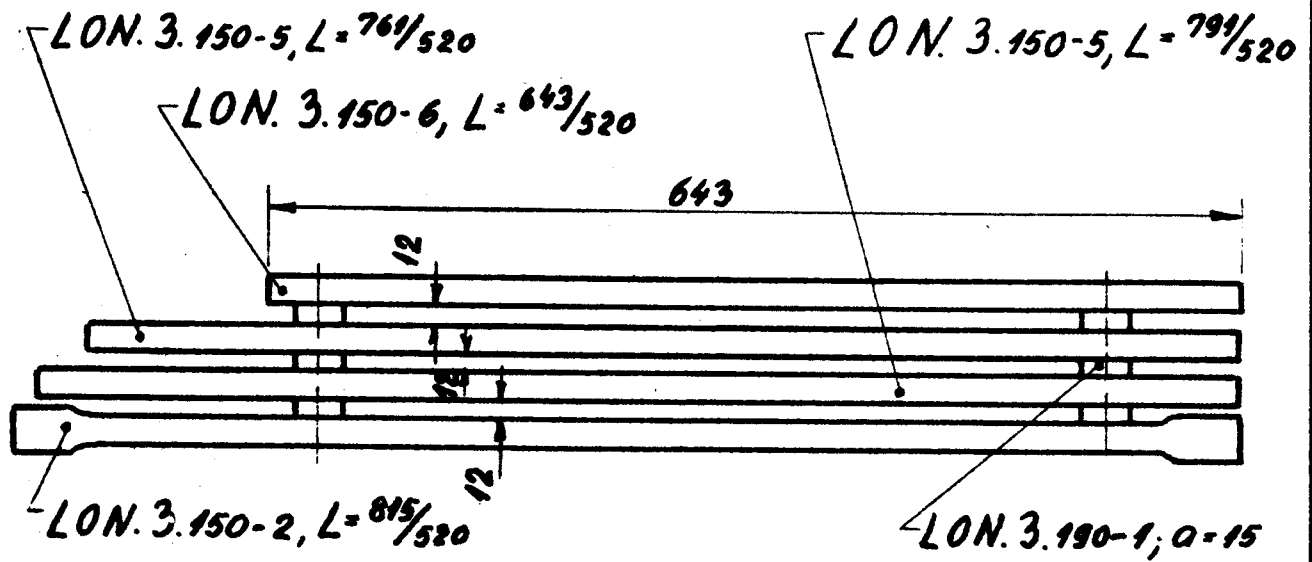
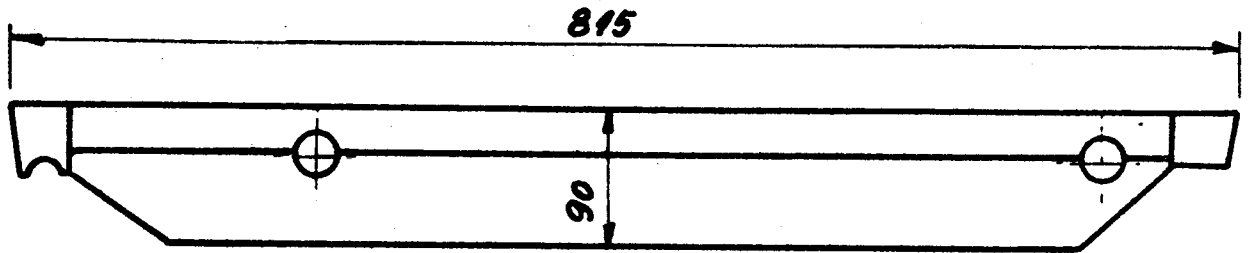

Venstreudtørelse som vist.

Højre — . — modsat .

| Rekvissionsbetegnelse | Materiale | Model Nr. | Mindstebeholdning |
|--------------------------|------------|-----------|-------------------|
| Bagsiderist LON 3.200-13 | Flussjern. | | Kh. Ar. |

6

0.

LON.
D.S.B.Bagsiderist
for Loko PR_I, PR_{II}.

3.200-14

1945

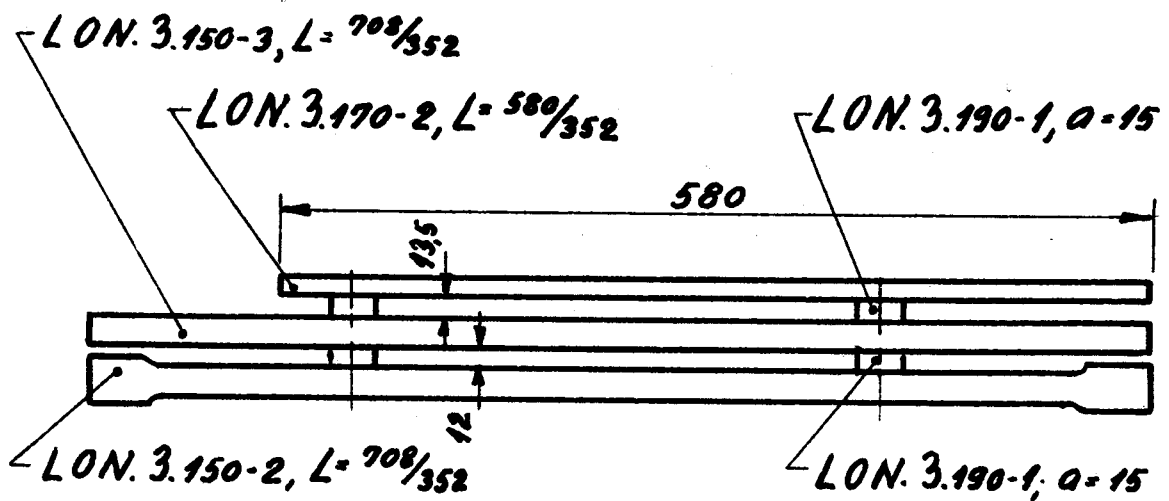
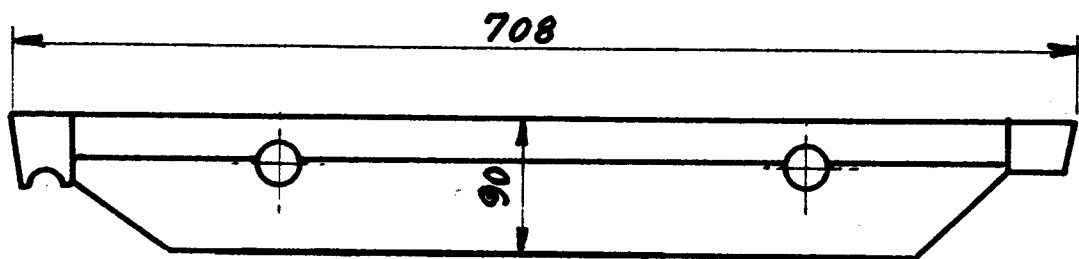

Venstreudførelse som vist
Højre — " — modsat "

| Rekvissionsbetegnelse | Materiale | Model Nr. | Mindesteholdn. |
|---------------------------|-----------|-----------|----------------|
| Bagsiderist LON. 3.200-14 | Flussjern | | Kh. Ar |

7

| | | |
|---------------|--|-----------|
| LON D.S.B. | Bageste Mellemsiderist for Loko P _{RI} , P _{RZ} | 3.200-15. |
|---------------|--|-----------|

1945

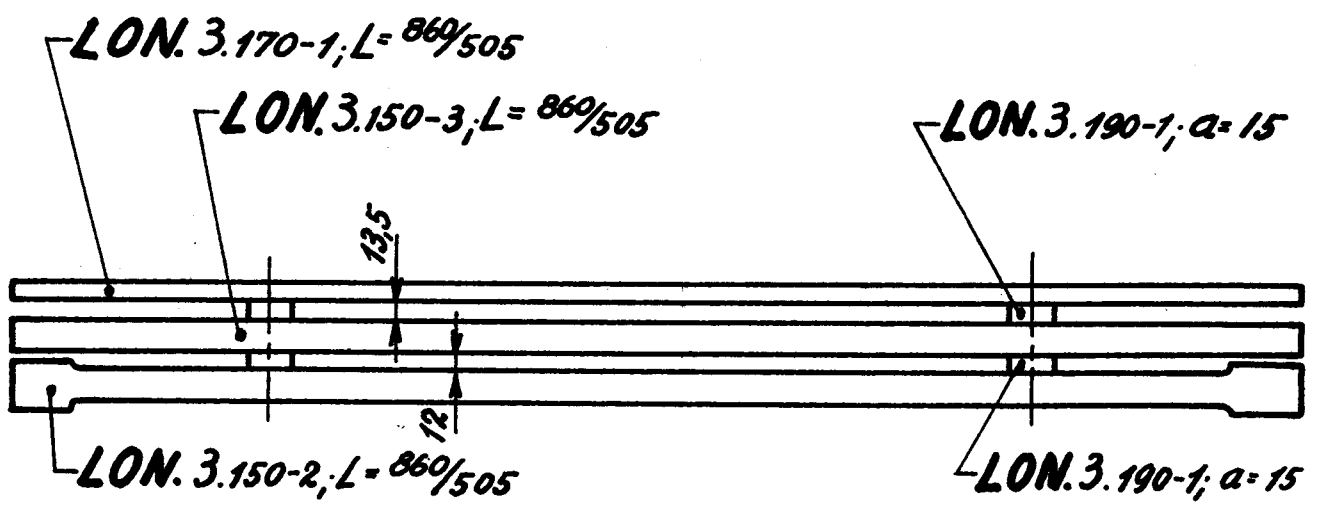
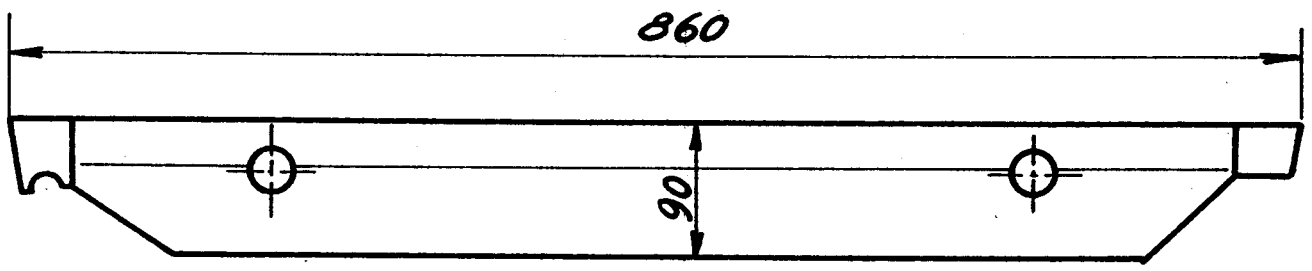

1

| Rekvissionsbetegnelse | Materiale | Model Nr. | Mindstebeholdn. | |
|------------------------------|-----------|-----------|-----------------|-----|
| Mellemsiderist LON.3.200-15. | Flussjern | | Kh. | Ar. |

0
1.

LON
D.S.B.

Forreste Mellemsiderist
for Loko P_RI, P_RII, T.

3.200-16.

1945

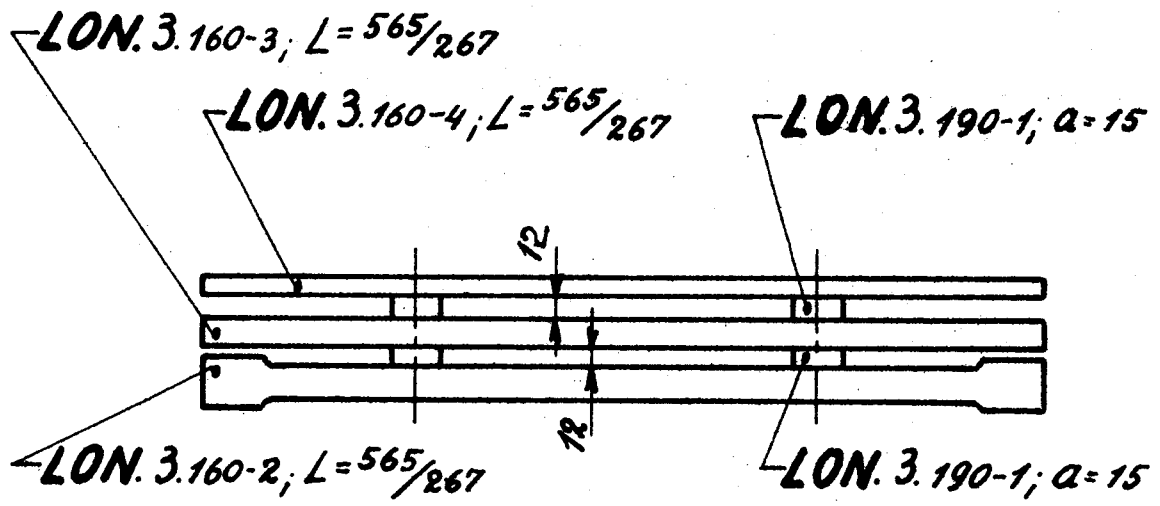
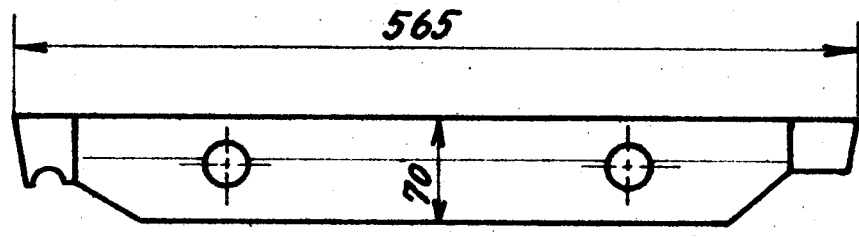

| Rekvisitionsbetegnelse | Materiale | Model Nr. | Mindstebeholdn. |
|------------------------------|-----------|-----------|-----------------|
| Mellemsiderist LON. 3.200-16 | Flussjern | | Kh. Ar. |

2

0

LON
D.S.B.Bagsiderist
for Loko Q_I, Q_{II}

3.200-17.

Kun for nittet Fyrkasse.

1945

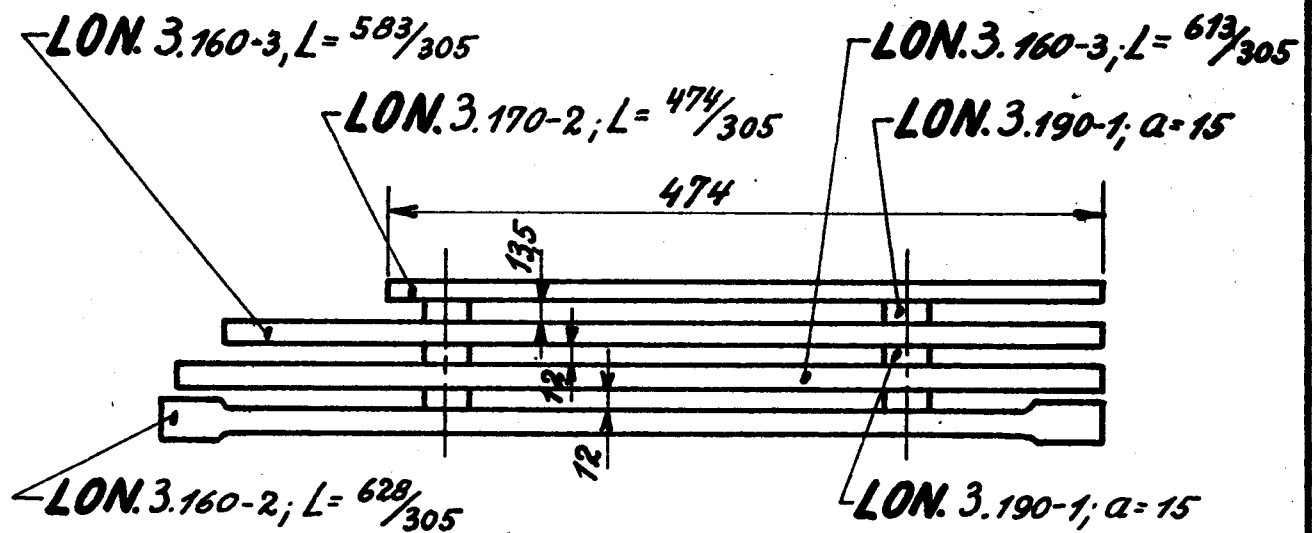
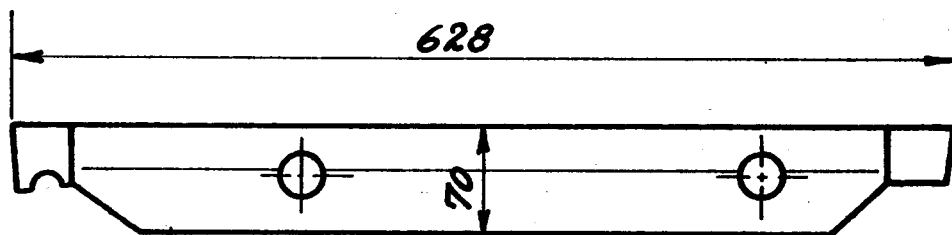

Venstreførelse som vist.

Højre — " — modsat " .

Rekvissionsbelegnelse

Materiale

Model Nr.

Mindstebeholdn.

Bagsiderist LON.3.200-17 { højre el.
venstre

Flussjern

Kh.

Ar.

3

0.
1.

LON
D.S.B.

Bagsiderist
for Loko Q_I, Q_{II}, AF_I, AF_{II}.

3.200-18.

Kun for svejst Fyrkasse.

1945

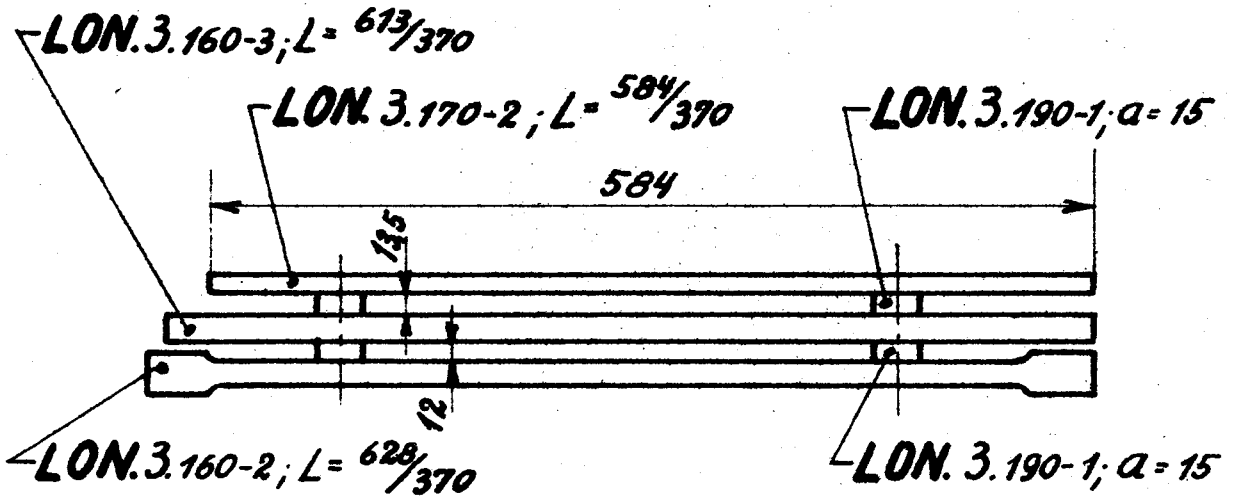
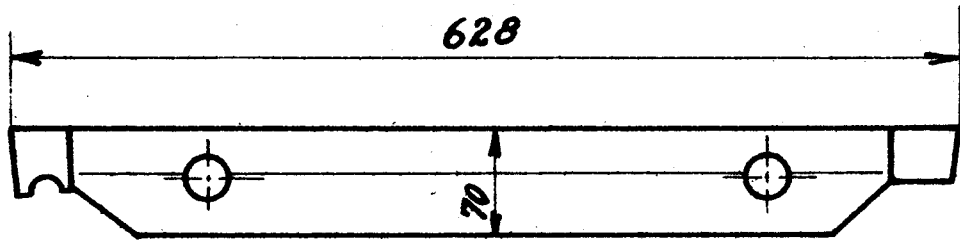

Venstreudførelse som vist.

Højre — " — modsat " .

| Rekvissionsbetegnelse | Materiale | Model Nr. | Mindstebeholdn |
|--------------------------|-----------|-----------|----------------|
| Bagsiderist LON.3.200-18 | Flussjern | | Kh. Ar. |

4

0.

LON
D.S.B.

Mellemsiderist
for Loko Q_I, Q_{II}

3.200-19.

1945

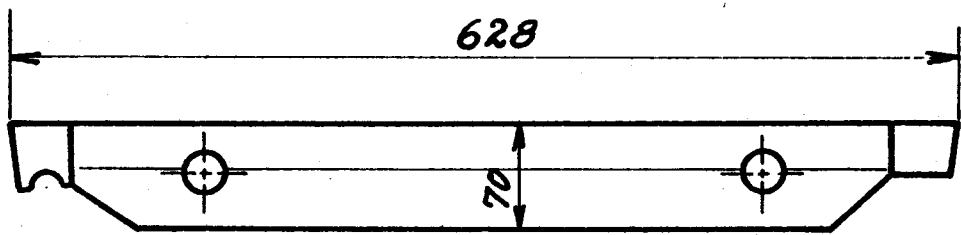

LON. 3.160-3; L = 628/370

LON. 3.170-1; L = 628/370

LON. 3.190-1; α = 15

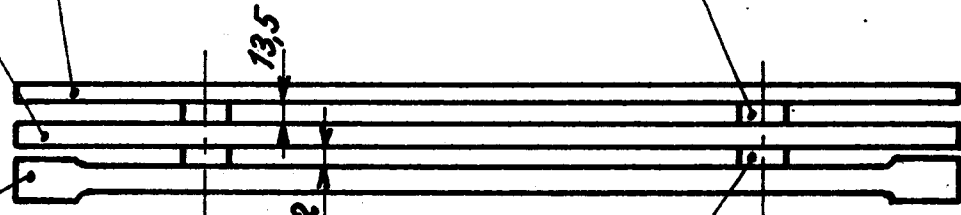

LON. 3.160-2; L = 628/370

LON. 3.190-1; α = 15

| Rekvissionsbetegnelse | Materiale | Model Nr. | Mindstebeholdn. |
|------------------------------|------------|-----------|-----------------|
| Mellemsiderist LON. 3.200-19 | Flussjern. | | Kh. Ar. |

5